

FLIR LEPTON® 3 Long Wave Infrared (LWIR) Datasheet

Document Number: 500-0726-01-09 Rev 100

General Description

Lepton® 3 is a complete long-wave infrared (LWIR) camera module designed to interface easily into native mobile-device interfaces and other consumer electronics. It captures infrared radiation input in its nominal response wavelength band (from 8 to 14 microns) and outputs a uniform thermal image.

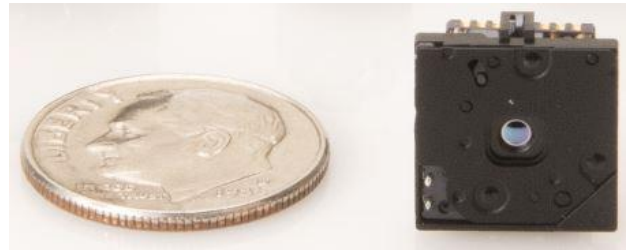

Features

- Integral shutter configuration:
 - 11.5 x 12.7 x 6.9 mm (without socket)
 - 11.8 x 12.7 x 7.2 mm (including socket)
- 56° HFOV, 71° diagonal (f/1.1 silicon doublet)
- LWIR sensor, wavelength 8 to 14 μm
- 160 (h) x 120 (v) active pixels
- Thermal sensitivity <50 mK
- Integrated digital thermal image processing functions, including automatic thermal environment compensation, noise filters, non-uniformity correction, and gain control
- Optional temperature-stable output to support radiometric processing
- Export compliant frame rate (< 9 Hz)
- SPI video interface
- Two-wire I2C serial control interface
- Uses standard cell-phone-compatible power supplies: 2.8V to sensor, 1.2V to digital core, and flexible IO from 2.8V to 3.1V
- Fast time to image (< 1.2 sec)
- One-time user-programmable defaults (initialization of settings no longer required at start-up)
- Low operating power, nominally 140 mW (< 150 mW over full temperature range) (~800mW typical during shutter event)
- Low power shutdown mode (nominally 5mW)
- RoHS compliant
- 32-pin socket interface to standard Molex or similar side-contact connector



Applications

- Mobile phones
- Gesture recognition
- Building automation
- Thermal imaging
- Night vision



Information on this page is subject to change without notice.
500-0726-01, Lepton 3 Datasheet, Rev: 100

FLIR LEPTON® 3 Long Wave Infrared (LWIR) Datasheet

Simplified Block Diagram

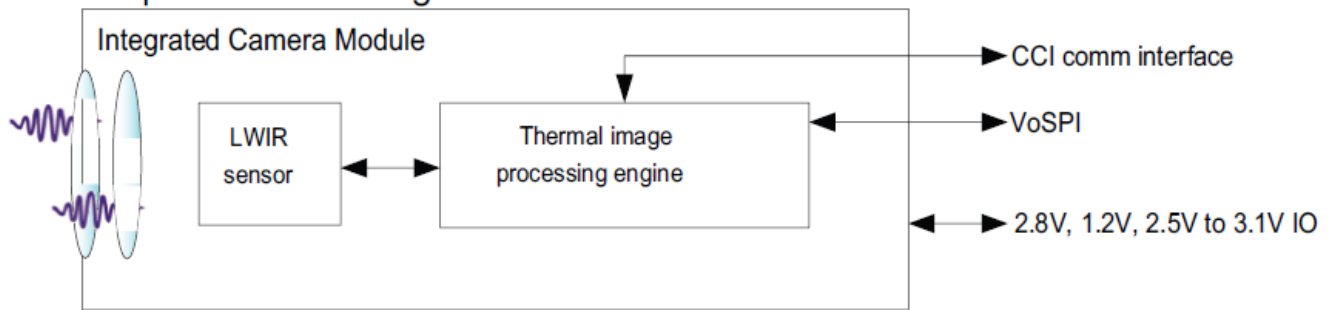

Table of Contents

1.0	Device Overview	5
2.0	Applications	6
3.0	Key Specifications.....	7
4.0	Lepton 3 Camera Module Pinout Diagram	9
5.0	Pin Descriptions.....	10
6.0	System Architecture.....	12
7.0	Functional Description	13
7.1	FPA Interface Module	13
7.2	System Control (Sys Ctrl) Module.....	13
7.3	Power Management Module.....	13
7.4	Software-based Video Processing (SVP Core) Module.....	14
7.5	Memory System (Memory Sys) Module	14
7.6	General Purpose Processor (GPP).....	14
7.7	Video Interface Module (Video IF).....	14
7.8	One-Time Programmable Memory (OTP).....	14
7.9	Static Random-Access Memory (SRAM)	14
7.10	GPIO Interface Module (GPIO IF).....	14
7.11	Video Pipeline.....	15
7.11.1	NUC.....	15
7.11.2	Defect Replacement	15
7.11.3	Spatial / Temporal Filtering	15
7.11.4	AGC	16
7.11.5	Colorize	16
7.12	Master Clock	16
8.0	Operating States and Modes	17
8.1	Power States.....	17
8.2	FFC States	20
8.3	Telemetry Modes.....	23
8.4	Radiometry Modes	26



Information on this page is subject to change without notice.
500-0726-01, Lepton 3 Datasheet, Rev: 100

FLIR LEPTON® 3 Long Wave Infrared (LWIR) Datasheet

8.4.1	Radiometry Disabled.....	26
8.4.2	Radiometry Enabled.....	27
8.5	AGC Modes.....	28
8.6	Video Output Format Modes.....	30
8.7	GPIO Modes.....	32
9.0	Interface Descriptions	33
9.1	Command and Control Interface	33
9.1.1	User Defaults Feature	34
9.2	VoSPI Channel	35
9.2.1	VoSPI Physical Interface	37
9.2.2	VoSPI Protocol.....	38
9.2.2.1	VoSPI Packets	39
9.2.2.2	VoSPI Segments.....	42
9.2.2.3	VoSPI Stream	43
9.2.2.3.1	Establishing/Re-Establishing Sync.....	44
9.2.2.3.2	Maintaining Segments	44
9.2.3	Frame Synchronization	46
9.2.4	VoSPI Protocol, Lepton vs. Lepton 3.....	46
10.0	Thermal Camera Basics.....	47
11.0	Mounting Specifications	48
11.1	Socket Information	49
11.2	Mechanical Considerations	50
11.3	Thermal Considerations.....	50
11.4	Optical Considerations.....	51
12.0	Spectral Response.....	52
13.0	Electrical Specifications	53
13.1	DC and Logic Level Specifications.....	53
13.2	AC Electrical Characteristics	53
13.3	Absolute Maximum Ratings.....	54
14.0	Environmental Specifications.....	55
14.1	Compliance with Environmental Directives.....	55
15.0	Abbreviations and Acronyms	56



Information on this page is subject to change without notice.
500-0726-01, Lepton 3 Datasheet, Rev: 100

FLIR LEPTON® 3 Long Wave Infrared (LWIR) Datasheet

Revision History

Revision	Date	Description of Change
100	04/03/2017	Lepton 3 release

Contact Us

email: SBA-CORES@FLIR.COM

<http://www.FLIR.com>

References

Lepton Software Interface Description Document (IDD) - OEM. Document #110-0144-04.

Lepton 3 Mechanical IDD, Document #500-0726-19

Lepton 3 STEP file



Information on this page is subject to change without notice.
500-0726-01, Lepton 3 Datasheet, Rev: 100

FLIR LEPTON® 3 Long Wave Infrared (LWIR) Datasheet

1.0 Device Overview

Lepton 3 is an infrared camera system that integrates a fixed-focus lens assembly, a 160x120 long-wave infrared (LWIR) microbolometer sensor array, and signal-processing electronics. The camera system includes an integral shutter assembly that is used to automatically optimize image uniformity on a periodic basis. Easy to integrate and operate, Lepton 3 is intended for mobile devices as well as any other application requiring very small footprint, very low power, and instant-on operation. Lepton 3 can be operated in its default mode or configured into other modes through a command and control interface (CCI).

Figure 1 shows a view of the Lepton 3 camera as standalone and mounted in a socket.

Figure 1 - Lepton 3 Camera (with and without socket)

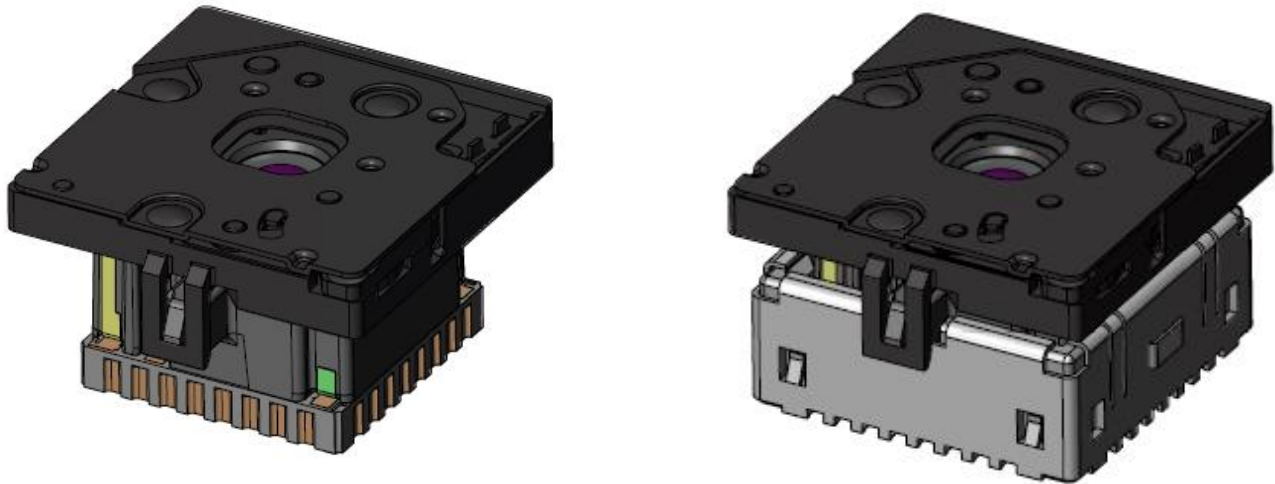

FLIR LEPTON[®] 3 Long Wave Infrared (LWIR) Datasheet

2.0 Applications

A typical application using the Lepton 3 camera module is shown in *Figure 2*.

Figure 2 - Typical Application

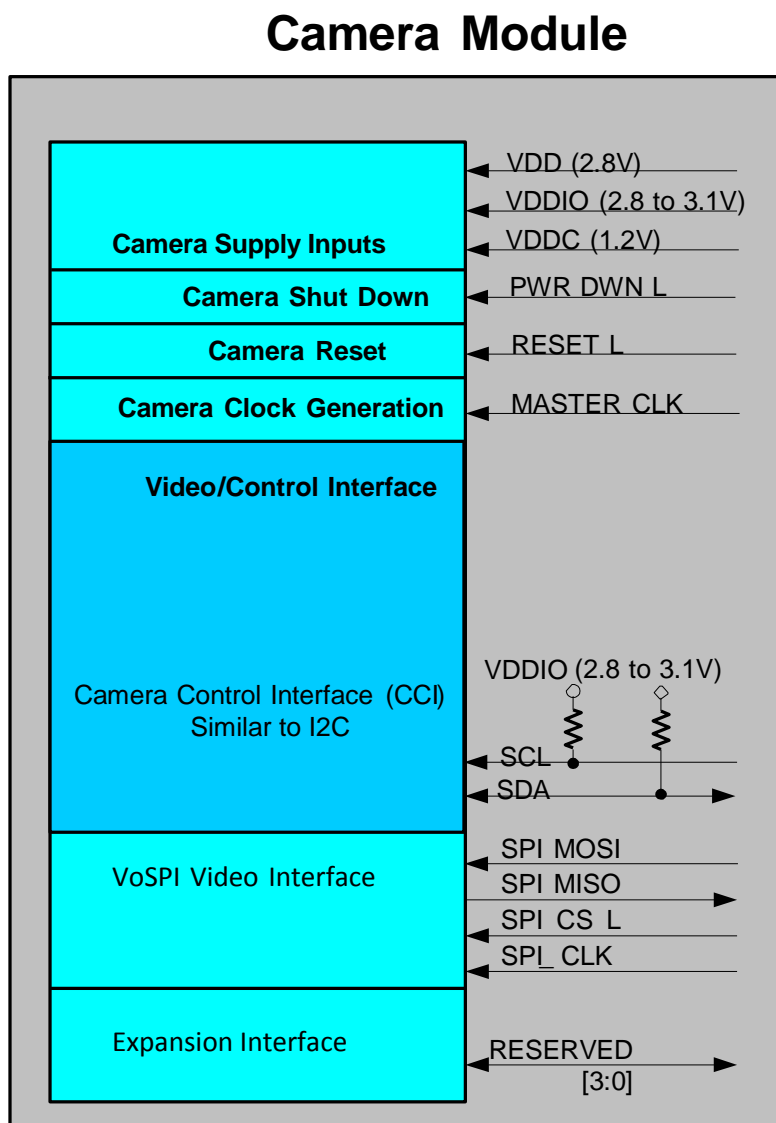

Note(s)

1. The CCI pullup resistors are required and must be handled outside the camera module by a host controller.



Information on this page is subject to change without notice.
500-0726-01, Lepton 3 Datasheet, Rev: 100

FLIR LEPTON® 3 Long Wave Infrared (LWIR) Datasheet

3.0 Key Specifications

The key specifications of the Lepton 3 camera module are listed in [Table 1](#). See [Figure 39, page 9](#) for the corresponding package pinout diagram.

Table 1 - Key Specifications

Specification	Description
Overview	
Function	Passive thermal imaging module for mobile equipment
Sensor technology	Uncooled VOx microbolometer
Spectral range	Longwave infrared, 8 μ m to 14 μ m
Array format	160 x 120, progressive scan
Pixel size	12 μ m
Effective frame rate	8.8 Hz (exportable)
Thermal sensitivity	<50 mK (0.050° C)
Temperature compensation	Automatic. Output image independent of camera temperature (optional mode - see Radiometry Modes, page 26).
Non-uniformity corrections	Shutterless, automatic (with scene motion) Shuttered (for stationary applications and best image quality)
FOV - horizontal	56°
FOV - diagonal	71°
Depth of field	28cm to infinity
Lens type	f/1.1 silicon doublet
Optical Distortion	13.3% (nominal corner magnitude)
Output format	User-selectable 14-bit, 8-bit (AGC applied), or 24-bit RGB (AGC and colorization applied)
Solar protection	Integral
Electrical	
Input clock	25-MHz nominal, CMOS IO Voltage Levels (see Master Clock, page 16)
Video data interface	Video over SPI (see VoSPI Channel, page 35)
Control port	CCI (I2C-like), CMOS IO Voltage Levels (see Command and Control Interface, page 33)
Input supply voltage (nominal)	2.8 V, 1.2 V, 2.8 V to 3.1 V IO (see DC and Logic Level Specifications, page 53)
Power dissipation	Nominally 140 mW at room temperature (operating), 5 mW (shutdown mode)
Mechanical	
Package dimensions	11.5 x 12.7 x 6.9 mm (w x l x h, without socket) 11.8 x 12.7 x 7.2 mm (w x l x h, including socket)
Weight	0.90 grams (typical)



Information on this page is subject to change without notice.
500-0726-01, Lepton 3 Datasheet, Rev: 100

FLIR LEPTON[®] 3 Long Wave Infrared (LWIR) Datasheet

Specification	Description
Environmental	
Optimum operating temperature range	-10 °C to +65 °C
Non-operating temperature range	-40 °C to +80 °C
Shock	1500 G @ 0.4 ms



Information on this page is subject to change without notice.
500-0726-01, Lepton 3 Datasheet, Rev: 100

FLIR LEPTON® 3 Long Wave Infrared (LWIR) Datasheet

4.0 Lepton 3 Camera Module Pinout Diagram

Figure 3 - Pinout Diagram (viewed from bottom of camera module)

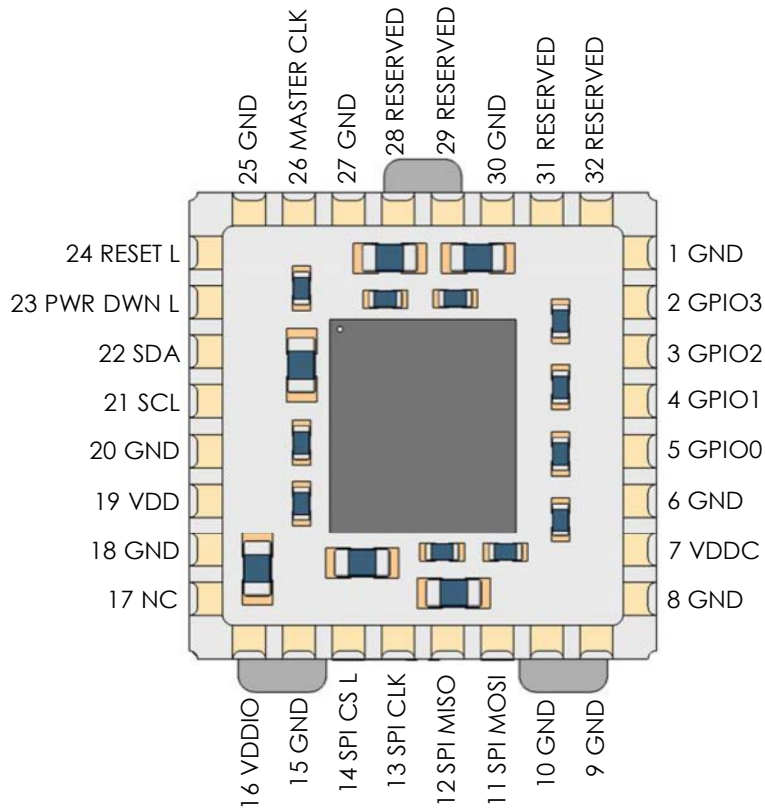

Information on this page is subject to change without notice.
500-0726-01, Lepton 3 Datasheet, Rev: 100

FLIR LEPTON® 3 Long Wave Infrared (LWIR) Datasheet

5.0 Pin Descriptions

The Lepton 3 camera module pin descriptions are shown in [Table 2](#).

Table 2 - Lepton 3 Camera Module Pin Descriptions

Pin #	Pin Name	Signal Type	Signal Level	Description
1, 6, 8, 9, 10, 15, 18, 20, 25, 27, 30	GND	Power	GND	Common Ground
2	GPIO3/VSYNC	IN/OUT	VDDIO	Video output synchronization (see GPIO Modes, page 32)
3	GPIO2	IN/OUT	VDDIO	Reserved
4	GPIO1	IN/OUT	VDDIO	Reserved
5	GPIO0	IN/OUT	VDDIO	Reserved
7	VDDC	Power	1.2V	Supply PLL, ASIC Core (1.2V +/- 5%)
11	SPI_MOSI	IN	VDDIO	Video Over SPI Slave Data In (see VoSPI Channel, page 35)
12	SPI_MISO	OUT	VDDIO	Video Over SPI Slave Data Out (see VoSPI Channel, page 35)
13	SPI_CLK	IN	VDDIO	Video Over SPI Slave Clock (VoSPI Channel, page 35)
14	SPI_CS_L	IN	VDDIO	Video Over SPI Slave Chip Select, active low (see VoSPI Channel, page 35)
16	VDDIO	Power	2.8 V — 3.1 V	Supply used for System IO
17	No connection	—	—	—
19	VDD	Power	2.8V	Supply for Sensor (2.8V +/- 3%).



Information on this page is subject to change without notice.
500-0726-01, Lepton 3 Datasheet, Rev: 100

FLIR LEPTON® 3 Long Wave Infrared (LWIR) Datasheet

Pin #	Pin Name	Signal Type	Signal Level	Description
21	SCL	IN	VDDIO	Camera Control Interface Clock, I2C compatible (see Command and Control Interface, page 33)
22	SDA	IN/OUT	VDDIO	Camera Control Interface Data, I2C compatible (see Command and Control Interface, page 33)
23	PWR_DWN_L	IN	VDDIO	This active low signal shuts down the camera
24	RESET_L	IN	VDDIO	This active low signal resets the camera
26	MASTER_CLK	IN	VDDIO	ASIC Master Clock Input (see Master Clock, page 16)
28	RESERVED			
29	RESERVED			
31	RESERVED			
32	RESERVED			



Information on this page is subject to change without notice.
500-0726-01, Lepton 3 Datasheet, Rev: 100

FLIR LEPTON® 3 Long Wave Infrared (LWIR) Datasheet

6.0 System Architecture

A simplified architectural diagram of the Lepton 3 camera module is shown in [Figure 4](#).

Figure 4 - Lepton 3 Architecture

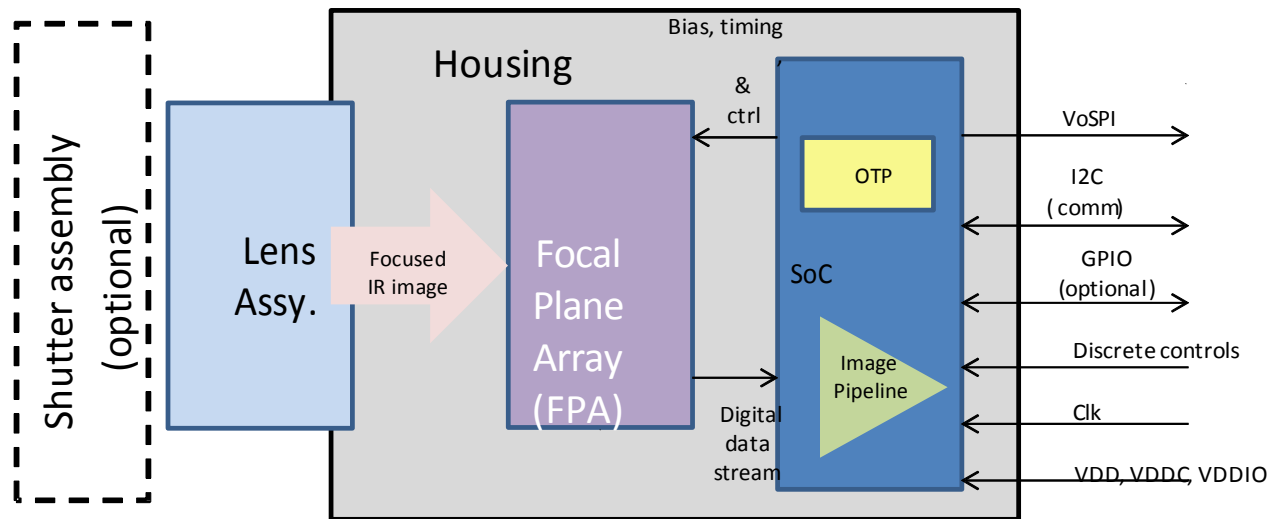

The lens assembly focuses infrared radiation from the scene onto a 160x120 array of thermal detectors with 12-micron pitch. Each detector element is a vanadium-oxide (VOx) microbolometer whose temperature varies in response to incident flux. The change in temperature causes a proportional change in each microbolometer's resistance. VOx provides a high temperature coefficient of resistance (TCR) and low 1/f noise, resulting in excellent thermal sensitivity and stable uniformity. The microbolometer array is grown monolithically on top of a readout integrated circuit (ROIC) to comprise the complete focal plane array (FPA). Once per frame, the ROIC senses the resistance of each detector by applying a bias voltage and integrating the resulting current for a finite period of time.

The shutter assembly periodically blocks radiation from the scene and presents a uniform thermal signal to the sensor array, allowing an update to internal correction terms used to improve image quality. For applications in which there is little to no movement of the Lepton 3 camera relative to the scene (for example, fixed-mount security applications), the shutter assembly is recommended. For applications in which there is ample movement (for example, handheld applications), the shutter assembly is less essential although still capable of providing slight improvement to image quality, particularly at start-up and when the ambient temperature varies rapidly.

The serial stream from the FPA is received by a system on a chip (SoC) device, which provides signal processing and output formatting. This device is more fully defined in [Functional Description, page 13](#).



FLIR LEPTON® 3 Long Wave Infrared (LWIR) Datasheet

7.0 Functional Description

A detailed block diagram of the Lepton 3 camera module is shown in [Figure 5 - Lepton 3 Detailed Block Diagram](#)

Figure 5 - Lepton 3 Detailed Block Diagram

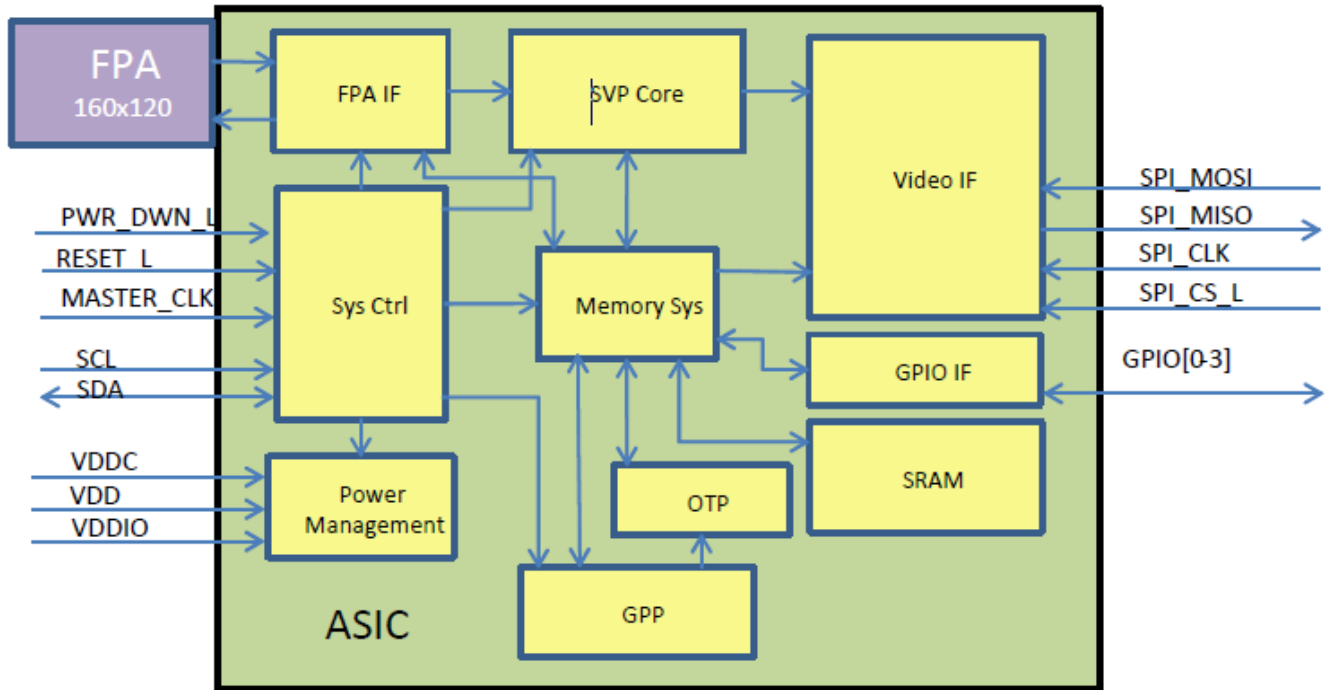

7.1 FPA Interface Module

The FPA Interface module generates timing and control signals to the FPA. It also receives and deserializes the digital data stream from the FPA. The output values of on-board temperature sensors are multiplexed into the pixel data stream, and the FPA Interface module strips these out and accumulates them (to improve SNR).

7.2 System Control (Sys Ctrl) Module

The System Control module provides the phase-lock-loop (PLL) and generates all clocks and resets required for other modules. It also generates other timing events including syncs and the internal watchdog timer. Additionally, it provides the boot controller, random-number generator, and command and control interface (CCI) decode logic.

7.3 Power Management Module

The Power Management module controls the power switches, under direction from the System Control Module.



FLIR LEPTON® 3 Long Wave Infrared (LWIR) Datasheet

7.4 Software-based Video Processing (SVP Core) Module

The SVP Core module is an asymmetric multi-core digital signal processor (DSP) engine that provides the full video pipeline, further described in [Video Pipeline, page 15](#).

7.5 Memory System (Memory Sys) Module

The Memory System module provides the memory interface to all of the other modules that require access to SRAM and/or OTP.

7.6 General Purpose Processor (GPP)

The GPP is a central processing unit (CPU) that provides the following functionality:

- Servicing of CCI commands
- Initialization and configuration of the video pipeline
- Power management
- Other housekeeping functions

7.7 Video Interface Module (Video IF)

The Video Interface module receives video data and formats it for VoSPI protocol.

7.8 One-Time Programmable Memory (OTP)

The OTP memory, 384 kBytes total, contains all the non-volatile data for the camera, including the software programs for the SVP Core and GPP as well as calibration data and camera-unique data (such as serial number). There are no requirements and no provisions for writing OTP memory outside of the Lepton 3 factory.

An optional feature is available to configure the desired defaults (e.g. FFC mode, radiometry configuration, etc.), and write these defaults once by the user to OTP. This feature removes the needs for an initialization sequence at start-up to configure the desired run-time settings. See [User Defaults Feature, page 34](#).

7.9 Static Random-Access Memory (SRAM)

SRAM is the primary volatile memory utilized by all other modules.

7.10 GPIO Interface Module (GPIO IF)

The General-Purpose Input / Output (GPIO) Interface module implements the GPIO pins, which can be runtime configured (see [GPIO Modes, page 32](#)).



Information on this page is subject to change without notice.
500-0726-01, Lepton 3 Datasheet, Rev: 100

FLIR LEPTON® 3 Long Wave Infrared (LWIR) Datasheet

7.11 Video Pipeline

A block diagram of the video pipeline is shown in [Figure 6](#). The video pipeline includes non-uniformity correction (NUC), defect replacement, spatial and temporal filtering, automatic gain correction (AGC), and colorization.

Figure 6 - Lepton 3 Video Pipeline Block Diagram

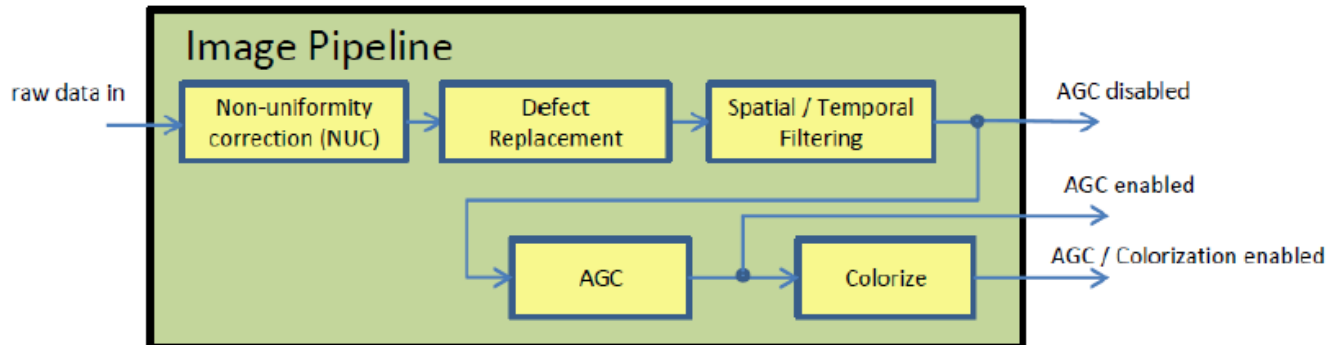

7.11.1 NUC

The non-uniformity correction (NUC) block applies correction terms to ensure that the camera produces a uniform output for each pixel when imaging a uniform thermal scene. Factory-calibrated terms are applied to compensate for temperature effects, pixel response variations, and lens-illumination roll-off. To compensate for temporal drift, the NUC block also applies an offset term that can be periodically updated at runtime via a process called flat-field correction (FFC). The FFC process is further described in [FFC States, page 20](#).

7.11.2 Defect Replacement

The defect-replacement block substitutes for any pixels identified as defective during factory calibration or during runtime. The replacement algorithm assesses the values of neighboring pixels and calculates an optimum replacement value.

7.11.3 Spatial / Temporal Filtering

The image pipeline includes a number of sophisticated image filters designed to enhance signal-to-noise ratio (SNR) by eliminating temporal noise and residual non-uniformity. The filtering suite includes a scene-based non-uniformity correction (SBNUC) algorithm which relies on motion within the scene to isolate fixed pattern noise (FPN) from image content.

FLIR LEPTON[®] 3 Long Wave Infrared (LWIR) Datasheet

7.11.4 AGC

The AGC algorithm for converting the full-resolution (14-bit) thermal image into a contrast-enhanced image suitable for display is a histogram-based non-linear mapping function. See [AGC Modes, page 28](#).

7.11.5 Colorize

The colorize block takes the contrast-enhanced thermal image as input and generates a 24-bit RGB color output. See [Video Output Format Modes, page 30](#).

7.12 Master Clock

The master clock (MASTER_CLOCK) frequency is 25 MHz.



Information on this page is subject to change without notice.
500-0726-01, Lepton 3 Datasheet, Rev: 100

FLIR LEPTON® 3 Long Wave Infrared (LWIR) Datasheet

8.0 Operating States and Modes

Lepton 3 provides a number of operating states and modes, more completely defined in the sections that follow:

- **Power States**
- **FFC States**
- **Telemetry Modes**
- **Radiometry Modes**
- **AGC Modes**
- **Video Output Format Modes**
- **GPIO Modes**

8.1 Power States

Lepton 3 currently provides five power states. As depicted in the state diagram shown in [Figure 7](#), most of the transitions among the power states are the result of explicit action from the host. The automatic transition to and from the overtemp state is an exception. In the figure, transitions that require specific host-side action are shown in bold. Automatic transitions are not bolded.

Figure 7 - State Diagram Showing Transitions among the Five Power States

Note: Transition to “off” from every other state occurs by **removing VDD, VDDC, and VDDIO**. For simplicity, these transitions are not shown below.

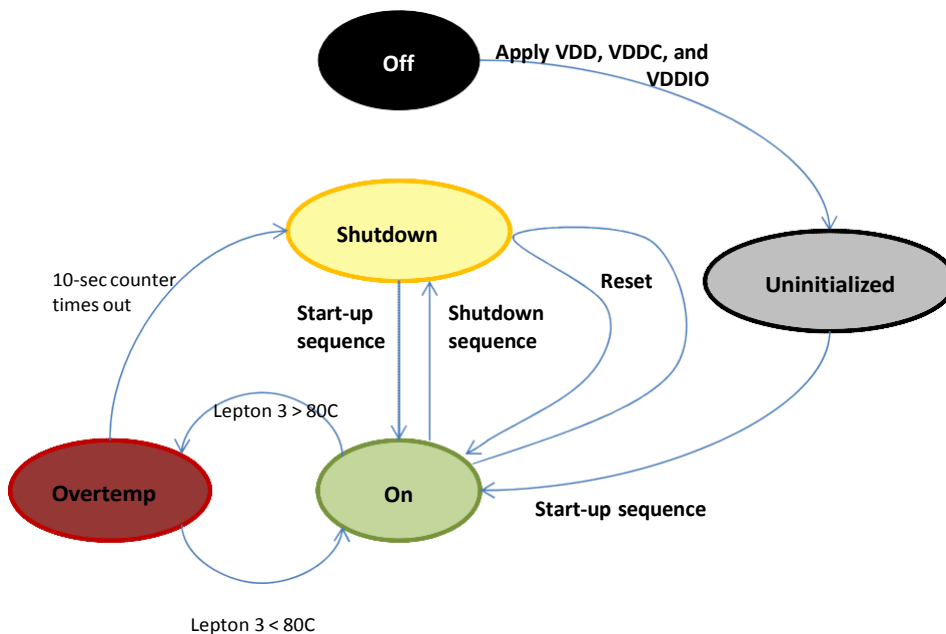

Information on this page is subject to change without notice.
500-0726-01, Lepton 3 Datasheet, Rev: 100

FLIR LEPTON[®] 3 Long Wave Infrared (LWIR) Datasheet

The power states are listed below:

- **Off:** When no voltage is applied, Lepton 3 is in the off state. In the off state, no camera functions are available.
- **Uninitialized:** In the uninitialized state, all voltage forms are applied, but Lepton 3 has not yet been booted and is in an indeterminate state. It is not recommended to leave Lepton 3 in this state as power is not optimized; it should instead be booted to the on-state (and then transitioned back to shutdown mode if imaging is not required).
- **On:** In the on state, all functions and interfaces are fully available.
- **Shutdown:** In the shutdown state, all voltage forms are applied, but power consumption is approximately 5 mW. In the shutdown state, no functions are available, but it is possible to transition to the on state via the start-up sequence defined in [Figure 8](#). The shutdown sequence also shown in [Figure 8](#) is the recommended transition back to the shutdown state. It is also possible to transition between shutdown and on states via software commands, as further defined in the software IDD.
- **Overtemp:** The overtemp state is automatically entered when the Lepton 3 senses that its temperature has exceeded approximately 80 °C. Upon entering the overtemp state, Lepton 3 enables a “shutdown imminent” status bit in the telemetry line and starts a 10-second counter. If the temperature of the Lepton 3 falls below 80 °C before the counter times out, the “shutdown imminent” bit is cleared and the system transitions back to the on state. If the counter does time out, Lepton 3 automatically transitions to the shutdown state.



Information on this page is subject to change without notice.
500-0726-01, Lepton 3 Datasheet, Rev: 100

FLIR LEPTON[®] 3 Long Wave Infrared (LWIR) Datasheet

Power sequencing is as shown in *Figure 8*.

Figure 8 - Power Sequencing

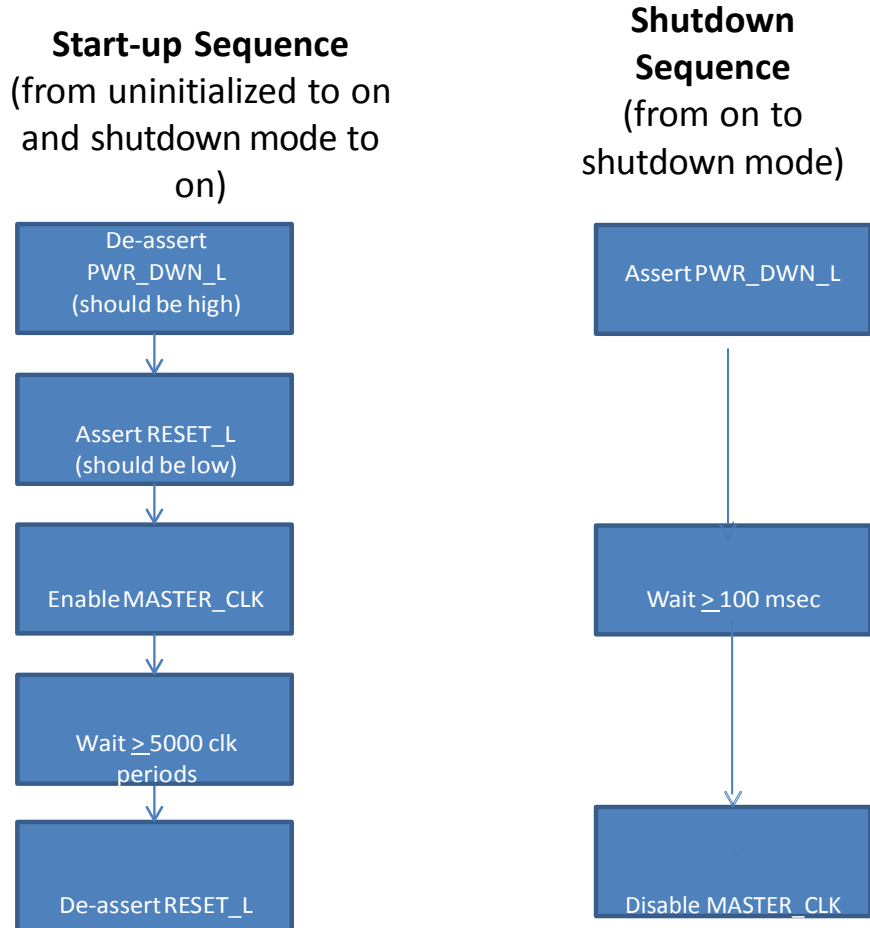

The World's Sixth Sense™

Information on this page is subject to change without notice.
500-0726-01, Lepton 3 Datasheet, Rev: 100

FLIR LEPTON[®] 3 Long Wave Infrared (LWIR) Datasheet

8.2 FFC States

Lepton 3 is factory calibrated to produce an output image that is highly uniform, such as shown in **Figure 9** (a), when viewing a uniform-temperature scene. However, drift effects over long periods of time degrade uniformity, resulting in imagery which appears more grainy (**Figure 9** (b)) and/or blotchy (**Figure 9** (c)). Operation over a wide temperature range (for example, powering on at -10 °C and heating to 65 °C) will also have a detrimental effect on image quality.

For scenarios in which there is ample scene movement, such as most handheld applications, Lepton 3 is capable of automatically compensating for drift effects using an internal algorithm called scene-based non-uniformity correction (scene-based NUC or SBNUC). However, for use cases in which the scene is essentially stationary, such as fixed-mount applications, scene-based NUC is less effective. In those applications, it is recommended to periodically perform a flat-field correction (FFC). FFC is a process whereby the NUC terms applied by the camera's signal processing engine are automatically recalibrated to produce the most optimal image quality. The sensor is briefly exposed to a uniform thermal scene, and the camera updates the NUC terms to ensure uniform output. The entire FFC process takes less than a second.

Figure 9 - Examples of Good Uniformity, Graininess, and Blotchiness



(a) Highly uniform image

(b) Grainy image
(high-spatial frequency noise)

(c) Blotchy image
(low-spatial frequency noise)

FLIR LEPTON® 3 Long Wave Infrared (LWIR) Datasheet

Lepton 3 provides three different FFC modes:

- External
- Manual
- Automatic (default for integral-shutter configuration)

In external FFC mode, FFC is only executed upon command, and it should only be commanded when the camera is imaging an external uniform source, such as a wall. Manual FFC mode is identical to external mode except that when FFC is commanded, Lepton 3 closes its integral shutter throughout the process. In other words, it is not necessary to ensure a uniform external scene before commanding FFC in manual FFC mode because the shutter serves as the uniform source.

In automatic FFC, the Lepton 3 camera will automatically perform FFC under the following conditions:

- At start-up
- After a specified period of time (default of 5 minutes) has elapsed since the last FFC
- If the camera temperature has changed by more than a specified value (default of 3 Celsius degrees) since the last FFC

The time trigger and the temperature-change trigger described above are both adjustable parameters via the CCI; however, the default values are recommended under most operating conditions.

The current FFC state is provided through the telemetry line. There are four FFC states, as illustrated in [Figure 10](#):

1. **FFC not commanded** (default): In this state, Lepton 3 applies by default a set of factory-generated FFC terms. In automatic FFC mode, this state is generally not seen because Lepton 3 performs automatic FFC at start-up.
2. **FFC imminent**: The camera only enters this state when it is operating in automatic FFC mode. The camera enters “FFC imminent” state at a specified number of frames (default of 54 frames, or approximately 2 seconds) prior to initiating an automatic FFC. The intent of this status is to warn the host that an FFC is about to occur.
3. **FFC in progress**: Lepton 3 enters this state when FFC is commanded from the CCI or when automatic FFC is initiated. The FFC duration is nominally 23 frames.
4. **FFC complete**: Lepton 3 automatically enters this state whenever a commanded or automatic FFC is completed.

Lepton 3 also provides an “FFC desired” flag in the telemetry line. The “FFC desired” flag is asserted under the same conditions that cause automatic FFC when in automatic FFC mode. That is, the “FFC desired” flag is asserted at start-up, when a specified period (default = 5 minutes) has elapsed since the last FFC, or when the sensor temperature has changed by a specified value (default = 3 Celsius degrees) since the last FFC. In automatic mode, the camera immediately enters “FFC imminent” state when “FFC desired” is true. In manual FFC mode and external FFC mode, the “FFC desired” flag is intended to indicate to the host to command an FFC at the next possible opportunity.



Information on this page is subject to change without notice.
500-0726-01, Lepton 3 Datasheet, Rev: 100

FLIR LEPTON® 3 Long Wave Infrared (LWIR) Datasheet

Lepton 3 automatically prohibits the shutter from operating when it detects the temperature to be outside the range -10° C to +65° C. For example, if the camera is operating at a temperature of 70° C, no automatic FFC will be performed, and the camera will ignore any commanded FFC if the FFC mode is “automatic” or “manual.” Normal operation of the shutter will automatically resume when the temperature is back within the valid range. A status flag is provided in the telemetry line indicating when shutter lockout is in effect.

Figure 10 - FFC States

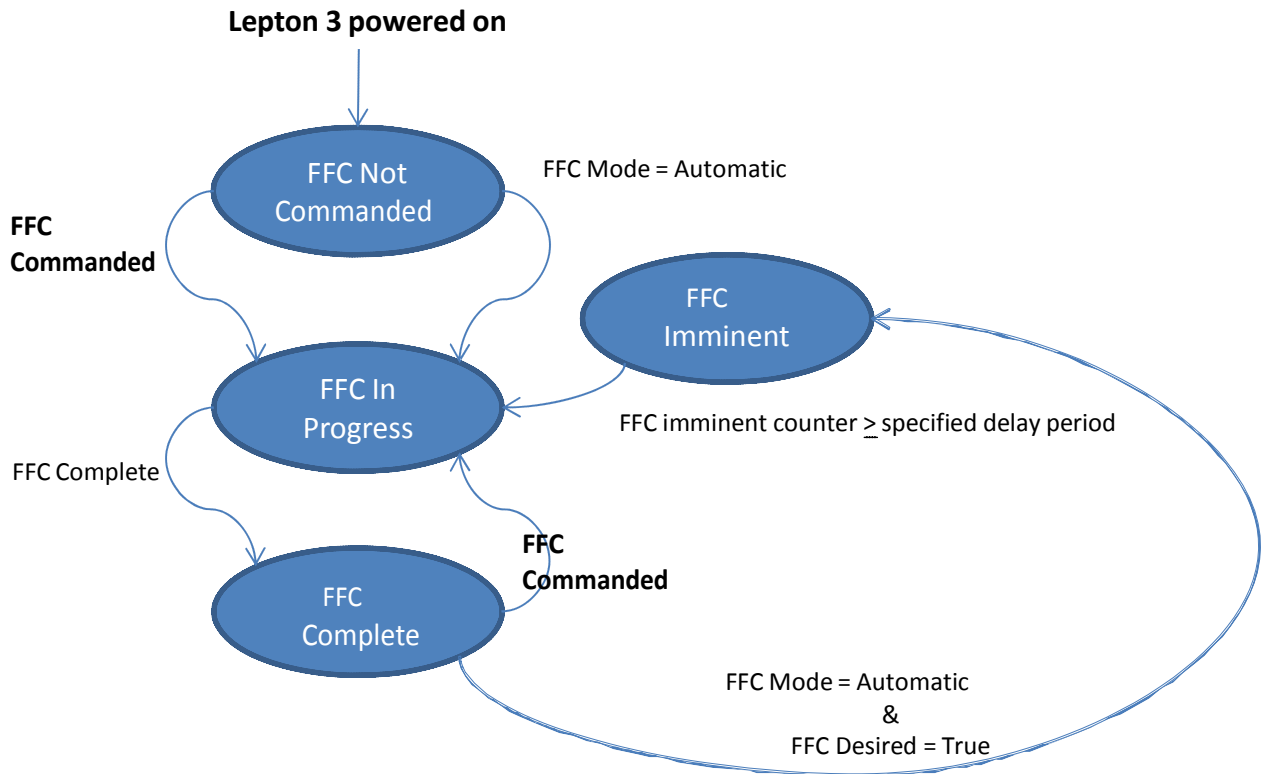

FLIR LEPTON® 3 Long Wave Infrared (LWIR) Datasheet

8.3 Telemetry Modes

There are three telemetry modes that affect the video output signal:

- Telemetry disabled (default)
- Telemetry as header
- Telemetry as footer

Explicit commands over the CCI select each mode. The contents and encoding of the telemetry data are shown in [Table 3](#). Note that the second line (line B) is reserved for future growth and contains no information at this time.

Table 3 - Telemetry Data Content and Encoding

Telemetry Row	Word start	Word End	Number of 16-bit Words	Name	Notes
A	0	0	1	Telemetry Revision	Format = major (byte 1), minor rev (byte 0).
A	1	2	2	Time Counter	32 bit counter in units of msec elapsed since boot-up
A	3	4	2	Status Bits	See Table 4, page 25
A	5	12	8	Reserved	
A	13	16	4	Software revision	
A	17	19	3	Reserved	
A	20	21	2	Frame Counter	32-bit counter of output frames
A	22	22	1	Frame Mean	
A	23	23	1	FPA Temp	In counts (prior to conversion to Kelvin)
A	24	24	1	FPA Temp	In Kelvin x 100

FLIR LEPTON[®] 3 Long Wave Infrared (LWIR) Datasheet

Telemetry Row	Word start	Word End	Number of 16-bit Words	Name	Notes
A	25	28	4	Reserved	
A	29	29	1	FPA Temp at last FFC	Updated every FFC. Units are Kelvin x100
A	30	31	2	Time Counter at last FFC	Updated every FFC. Units are msec
A	32	33	2	Reserved	
A	34	37	4	AGC ROI	(top, left, bottom, right)
A	38	38	1	AGC Clip-Limit High	See AGC Modes, page 28
A	39	39	1	AGC Clip-Limit Low	
A	40	71	32	Reserved	
A	72	73	2	Video Output Format	See Video Output Format Modes, page 30
A	74	159	86	Reserved	
B	0	159	160	Reserved	



Information on this page is subject to change without notice.
500-0726-01, Lepton 3 Datasheet, Rev: 100

FLIR LEPTON® 3 Long Wave Infrared (LWIR) Datasheet

Table 4 shows the encoding of the status bits (Telemetry Row A, Words 3 and 4).

Table 4 - Status Bit Encoding (Telemetry Row A, words 3 and 4)

Bit start	Bit end	Number of Bits	Name	Notes
0	2	3	Reserved	
3	3	1	FFC Desired ¹	0 = FFC not desired 1 = FFC desired
4	5	2	FFC State ¹	00 = FFC never commanded 01 = FFC imminent 10 = FFC in progress 11 = FFC complete
6	11	6	Reserved	
12	12	1	AGC State	0=Disabled 1=Enabled
13	14	2	Reserved	
15	15	1	Shutter lockout ¹	0 = Shutter not locked out 1 = Shutter locked out (outside of valid temperature range, -10° C to 65° C)
16	19	4	Reserved	
20	20	1	Overtemp shut down imminent	Goes true 10 seconds before shutdown (see Power States, page 17)
21	31	11	Reserved	

Note(s)

1. See [FFC States, page 20](#).



Information on this page is subject to change without notice.
500-0726-01, Lepton 3 Datasheet, Rev: 100

FLIR LEPTON[®] 3 Long Wave Infrared (LWIR) Datasheet

8.4 Radiometry Modes

There are two radiometry modes that affect the video output signal:

- Radiometry disabled (default)
- Radiometry enabled

The radiometric modes affect the transfer function between incident flux (scene temperature) and pixel output. From an image-quality standpoint, both radiometry modes produce nearly identical performance (no change in NEDT), and either mode is appropriate for strict imaging applications. However, for applications in which it is intended to convert the Lepton 3 output signal to one proportional to scene temperature, the radiometry-enabled mode is preferred because the conversion is constant over the full operating temperature range of the camera. Note that the following discussion assumes AGC is disabled (see [AGC Modes, page 28](#)). If AGC is enabled, the differences between the two radiometry modes are completely obscured by the AGC algorithm. In other words, with AGC enabled, any differences in signal output between radiometry-disabled and radiometry-enabled modes are negligible.

8.4.1 Radiometry Disabled

With radiometry disabled, the output of a given pixel is intended to be near the middle of the 14-bit range (~8192) when viewing a scene with a temperature equal to the temperature of the camera. Furthermore, the responsivity, which is defined as the change in pixel output value for a change in scene temperature, varies over the camera's operating temperature range. The resulting output for three different scene temperatures is illustrated hypothetically in [Figure 11](#) (note that the figure is for illustration purposes and not perfectly representative).

Figure 11 - Hypothetical Illustration of Camera Output vs. Camera Temperature in Radiometry-disabled Mode

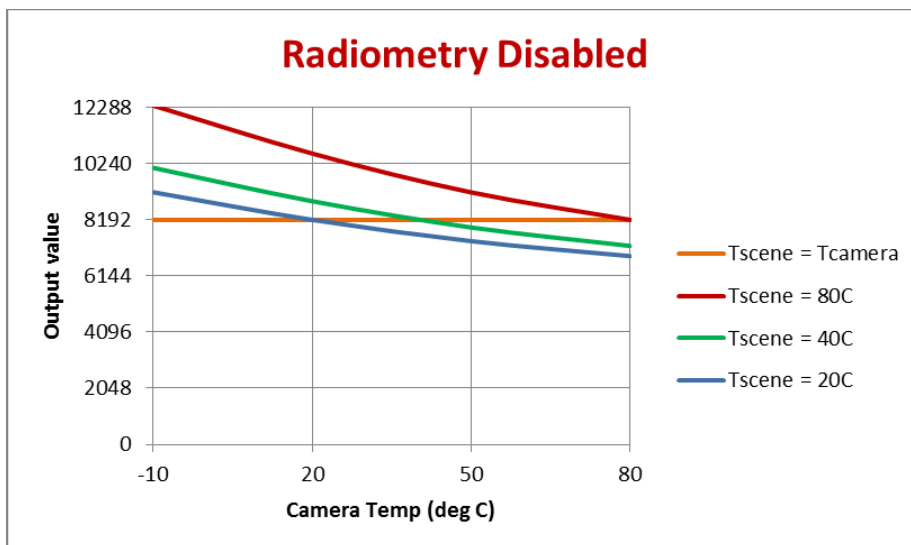

Information on this page is subject to change without notice.
500-0726-01, Lepton 3 Datasheet, Rev: 100

FLIR LEPTON[®] 3 Long Wave Infrared (LWIR) Datasheet

8.4.2 Radiometry Enabled

With radiometry enabled, Lepton 3 performs internal adjustments to the signal level such that in principle the output is independent of the camera's own temperature. The resulting output for three different scene temperatures is illustrated hypothetically in *Figure 12*. Notice in *Figure 12* that the output is only a function of scene temperature, not camera temperature (again, the figure is for illustration purposes only and not perfectly representative. In practice, there is slight output variation as camera temperature changes, particularly when the temperature change is rapid). Also notice that responsivity is also independent of camera temperature; that is, the difference in output between two different scene temperatures is a constant, as opposed to in *Figure 11 on page 26*, where it decreases with increasing camera temperature.

Figure 12 - Hypothetical Illustration of Camera Output vs. Camera Temperature in Radiometry-enabled Mode

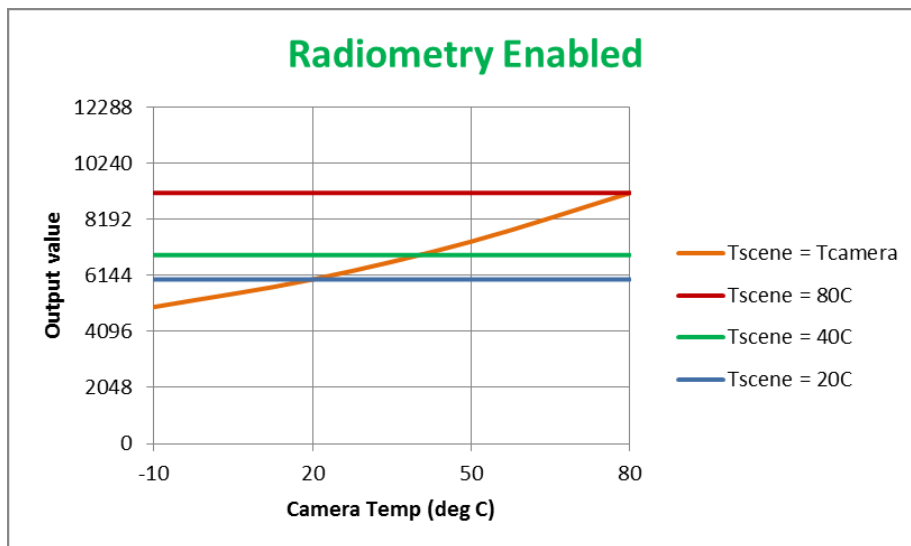

FLIR LEPTON® 3 Long Wave Infrared (LWIR) Datasheet

8.5 AGC Modes

There are two AGC modes:

- **AGC disabled** (default)
- **AGC enabled** (see AGC HEQ Output Scale Factor and AGC Calculation Enable State in the Software IDD for additional, related options)

AGC is a process whereby the large dynamic range of the infrared sensor is collapsed to a range more appropriate for a display system. For Lepton 3, this is a 14-bit to 8-bit conversion. In its most simplistic form, AGC can be a linear mapping from 14-bit to 8-bit; however, a simple linear AGC is generally incapable of providing pleasing imagery in all imaging conditions. For example, when a scene includes both cold and hot regions (for example, a hot object in front of a cold background as illustrated in [Figure 14 on page 29](#)), linear AGC can produce an output image in which most pixels are mapped to either full black or full white with very little use of the grayshades (8-bit values) in between. Because of this limitation of linear AGC, a more sophisticated algorithm is preferred.

Similar to most AGC algorithms that optimize the use of grayshades, Lepton 3's is histogram-based. Essentially a histogram counts the number of pixels in each frame that have a given 14-bit value. [Figure 13](#) illustrates the concept for a 3x3 pixel area.

Figure 13 - Illustration of a Histogram for a 3x3 Pixel Area

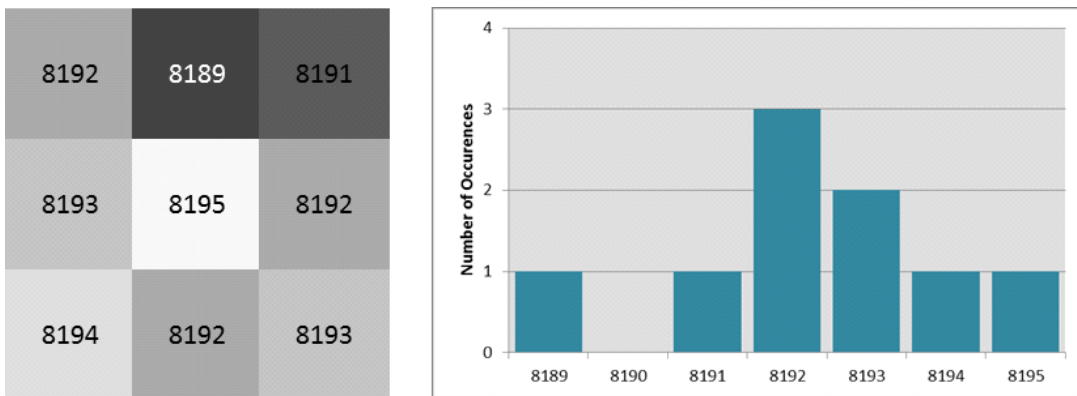

Classic histogram equalization (HEQ) uses the cumulative histogram as a mapping function between 14-bit and 8-bit. The intent is to devote the most grayshades to those portions of the input range occupied by the most pixels. For example, an image consisting of 60% sky devotes 60% of the available grayshades to the sky, leaving only 40% for the remainder of the image. By comparison, linear AGC “wastes” grayshades when there are gaps in the histogram, whereas classic histogram equalization allocates no grayshades to the gaps. This behavior is in principle an efficient use of the available grayshades, but there are a few drawbacks:

- The resulting contrast between an object and a much colder (or hotter) background can be rendered poor by the fact the algorithm “collapses” the separation between such that the object is only 1 grayshade above the background. This phenomenon is illustrated in [Figure 14](#).



Information on this page is subject to change without notice.
500-0726-01, Lepton 3 Datasheet, Rev: 100

FLIR LEPTON® 3 Long Wave Infrared (LWIR) Datasheet

- Too much emphasis can be placed on background clutter, particularly when a mostly isothermal background comprises a large fraction of the total image area. This is also illustrated in [Figure 14](#).
- For scenes with low dynamic range or less content, both the Linear AGC and Classic HEQ algorithms allow the application of a high amount of gain to the histogram resulting in more contrast but increasing noise.

The Lepton 3 AGC algorithm is a modified version of classic histogram equalization that mitigates these shortcomings. One such modification is a “clip limit high” function, which clips the maximum population of any single bin, limiting the influence of heavily populated bins on the mapping function. Another feature utilized by the Lepton 3 algorithm is called “linear percent.” It adds a percentage of the total number of pixels to every non-zero bin in the histogram, resulting in additional contrast between portions of the histogram separated by gaps. The “maximum gain” function is an improvement to classic histogram equalization and the Lepton AGC algorithm. It limits the amount of gain applied when the dynamic range of the 14-bit image is less than 255 bins, thus limiting the amount of noise in the output AGC image. [Figure 14](#) is an example showing the benefit of the Lepton parameters.

Figure 14 - Comparison of Linear AGC, Classic HEQ, and the Lepton Variant of HEQ

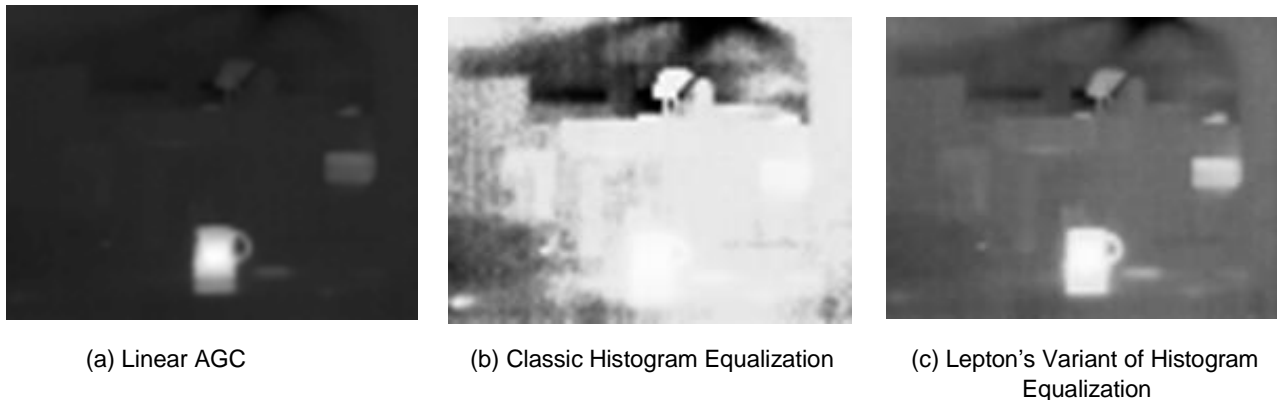

By default, the histogram used to generate Lepton 3's 14-bit to 8-bit mapping function is collected from the full array. In some applications, it is desirable to have the AGC algorithm ignore a portion of the scene when collecting the histogram. For example, in some applications it may be beneficial to optimize the display to a region of interest (ROI) in the central portion of the image. When the AGC ROI is set to a subset of the full image, any scene content located outside of the ROI is not included in the histogram and therefore does not affect the mapping function (note: this does not mean the portion outside of the ROI is not displayed or that AGC is not applied there, only that those portions outside the AGC ROI do not influence the mapping function).

FLIR LEPTON[®] 3 Long Wave Infrared (LWIR) Datasheet

8.6 Video Output Format Modes

There are two video-output format modes:

- **Raw14 (default)**
- **RGB888**

The first mode is appropriate for viewing 14-bit data (AGC disabled) or 8-bit data without colorization. The second mode is for viewing data after application of the colorization look-up table (LUT) to generate 24-bit RGB data. This capability is further described below. Note that the two output format modes result in different packet sizes for the VoSPI output data (see [VoSPI Protocol, page 38](#)). To properly view RGB888 data, the following order of operations should be followed:

1. Disable telemetry if required (telemetry is not valid in RGB888 mode)
2. Enable AGC (colorization without AGC is not a valid permutation)
3. Select RGB888 mode
4. Synchronize or re-synchronize the VoSPI channel (see [Establishing/Re-Establishing Sync, page 44](#))
5. Optional: Select a desired built-in LUT or upload a custom LUT.

The purpose of RGB888 mode is to generate a “false color” RGB image in which each grayscale value is converted by means of a user-specified look-up table (typically called a color palette) to a particular color. [Figure 15, page 31](#) shows the 8 built-in color palettes provided in the current release of Lepton 3, and [Figure 16, page 32](#) shows an example image with a color palette applied. The built-in color palettes are selectable by means of the command and control interface (see the Lepton Software Interface Description Document for more information on the palette format). Additionally, a user-specified palette can be uploaded through the command and control interface.



Information on this page is subject to change without notice.
500-0726-01, Lepton 3 Datasheet, Rev: 100

FLIR LEPTON® 3 Long Wave Infrared (LWIR) Datasheet

Figure 15 - Built-in Color Palette

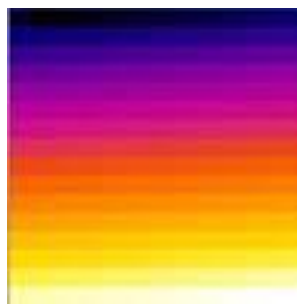

The upper left corner represents the color associated with an 8-bit input value of 0. The lower right corner represents the color associated with an input value of 255.



(a) Wheel 6



(b) Fusion (default)



(c) Rainbow



(d) Globow



(e) Sepia



(f) Color



(g) Ice Fire



(h) Rain

FLIR LEPTON 3[®] Long Wave Infrared (LWIR) Datasheet

Figure 16 - Comparison of an Identical Image with Grayscale and a False-color Palette

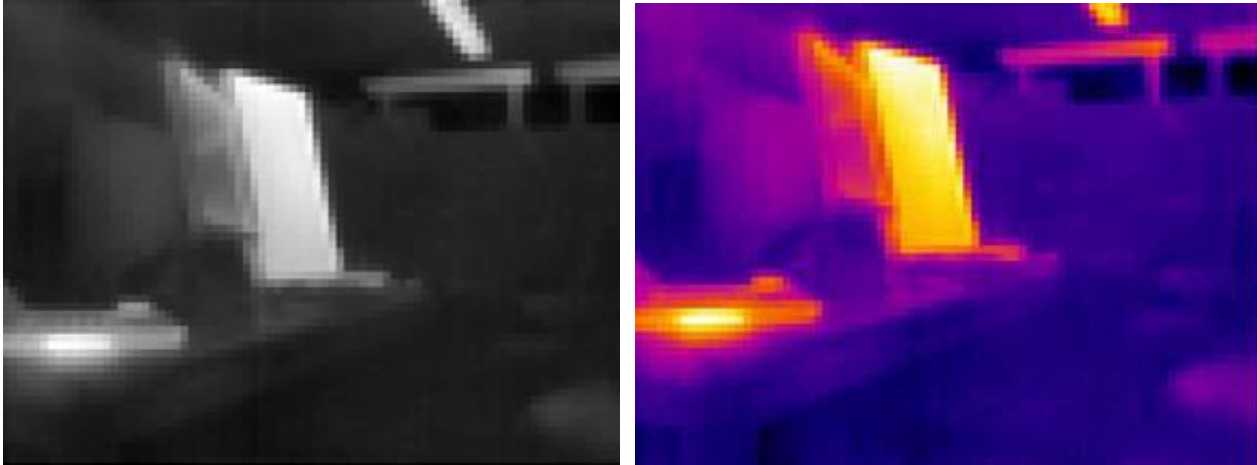

(a) Grayscale

(b) False Color

8.7 GPIO Modes

There are two supported GPIO modes:

- Disabled (default)
- VSYNC enabled

In disabled mode, no signals are provided as input or output on the GPIO pins. In VSYNC mode, a video sync signal is provided as an output on GPIO3. The purpose of this signal is more fully described in [Frame Synchronization, page 46](#).



NOTE: GPIO0, GPIO1, and GPIO2 should not be connected, regardless of the selected GPIO mode.

FLIR LEPTON 3[®] Long Wave Infrared (LWIR) Datasheet

9.0 Interface Descriptions

9.1 Command and Control Interface

Lepton 3 provides a command and control interface (CCI) via a two-wire interface similar to I2C (the only difference relative to the true I2C standard is that all Lepton 3 registers are 16 bits wide and consequently, only 16-bit transfers are allowed). The Lepton CCI bus should be driven by I2C drivers with at least Fast-mode drive capability. The CCI address is 0x2A. The interface is described in detail in a separate document, the Lepton Software Interface Description Document (IDD), FLIR document #110-0144-03. Generally, all commands issued through the CCI take the form of a “get” (reading data), a “set” (writing data), or a “run” (executing a function). [Table 5](#) shows a partial list of parameters / features controllable through the CCI. The command “OEM Set User Defaults” allows the current parameter settings to be stored as permanent power-on defaults. This capability allows the camera to be configured in factory environment prior to installation in an embedded system.

Table 5 - Partial List of Parameters Controllable through the CCI

Parameter	Power-On Default	Section in this document	Telemetry Line Location
AGC Mode	Disabled	AGC Modes, page 30	A3-4
AGC ROI	(0,0,159,119)	AGC Modes, page 30	A34-A37
AGC Dampening Factor	64	AGC Modes, page 30	A42
AGC Clip Limit High	19200	AGC Modes, page 30	A38
SYS Telemetry Mode	Disabled	Telemetry Modes, page 25	n/a
SYS Telemetry Location	Footer	Telemetry Modes, page 25	n/a
SYS Number of Frames to Average	8	FFC States, page 21	A74
VID Color LUT Select	Fusion	Video Output Format Modes, page 32	n/a
VID User Color LUT Upload/Download	n/a	Video Output Format Modes, page 32	n/a
OEM FFC	n/a	FFC States, page 21	A3-4
OEM Video Output Format	Raw14	Video Output Format Modes, page 32	A3-4
OEM GPIO Mode	Disabled	GPIO Modes, page 34	n/a
OEM GPIO VSYNC Phase Delay	0 lines	Frame Synchronization, page 44	n/a
OEM Set User Defaults	n/a		n/a



FLIR LEPTON 3[®] Long Wave Infrared (LWIR) Datasheet

9.1.1 User Defaults Feature

The user defaults feature allows the user to write desired operational defaults, such as those described in the CCI above, to OTP such that an initialization sequence is not necessary at start-up. The "OEM User Defaults" command is described in the Software IDD. The list of parameters that are included in the user defaults memory location are described in [Table 6](#).

Table 6 - Parameters Stored in the User Defaults OTP Memory Location

Parameter	Power-On Default	Section in this Document
AGC Mode	Disabled	AGC Modes, page 28
AGC ROI	(0,0,159,119)	AGC Modes, page 28
AGC Dampening Factor	64	AGC Modes, page 28
AGC Clip Limit High	19200	AGC Modes, page 28
AGC Clip Limit Low	512	AGC Modes, page 28
SYS Telemetry Mode	Disabled	Telemetry Modes, page 23
SYS Telemetry Location	Footer	Telemetry Modes, page 23
SYS Number of Frames to Average	8	FFC States, page 20
SYS Scene Stats ROI	0,0,119,159	
SYS FFC Mode	Auto	FFC States, page 20
SYS FFC Period	300000	FFC States, page 20
SYS FFC Temp Delta	300	FFC States, page 20
VID Color LUT Select	Fusion	Video Output Format Modes, page 30
OEM Video Output Format	Raw14	Video Output Format Modes, page 30
OEM GPIO Mode	Disabled	GPIO Modes, page 32
OEM GPIO VSYNC Phase Delay	0 lines	Frame Synchronization, page 46
RAD Radiometry Control	Enabled	Radiometry Modes, page 26

This feature is intended to be performed at the OEM's factory, because it requires an additional voltage supply and pin connection that should not be connected in run-time operation. The Lepton module pin connection for the programming voltage is described in [Table 7](#) below, and the electrical specifications for the supply are defined in [Table 8](#) below.



FLIR LEPTON 3[®] Long Wave Infrared (LWIR) Datasheet

Table 7 - Lepton Camera Module Pin Description for VPROG

Pin #	Pin Name	Signal Type	Signal Level	Description
17	VPROG	Power	5.9V	Supply for Programming to OTP (5.9V +/- 2%).

Table 8 - Electrical Specifications for VPROG

Symbol	Parameter	Min	Typ	Max	Units
VPROG	Programming Voltage (power for programming OTP)	5.79	5.9V	6.01	Volts

9.2 VoSPI Channel

Note to customers familiar with the Lepton VoSPI channel: see section 9.2.4 VoSPI Protocol, Lepton vs. Lepton 3 which concisely summarizes the key protocol differences for Lepton 3.

The Lepton 3 VoSPI protocol allows efficient and verifiable transfer of video over a SPI channel. The protocol is packet-based with no embedded timing signals and no requirement for flow control. The host (master) initiates all transactions and controls the clock speed. Data can be pulled from the Lepton 3 (the slave) at a flexible rate. This flexibility is depicted in [Figure 17](#), which shows the use of a relatively slow clock utilizing most of the available readout period as well as the use of a fast clock that bursts data. Once all data for a given segment is read, the master has the option to stop the clock and/or deassert the chip select until the next available segment. Alternatively, the master can simply leave the clock and chip select enabled, in which case Lepton 3 transmits discard packets until the next valid video data is available.



Information on this page is subject to change without notice.
500-0726-01, Lepton 3 Datasheet, Rev: 100

FLIR LEPTON 3[®] Long Wave Infrared (LWIR) Datasheet

Figure 17 - VoSPI Flexible Clock Rate

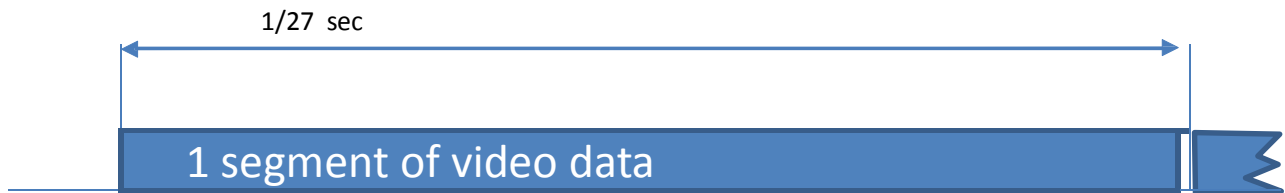

9.2.2 $F_{SCLK} \sim 10$ MHz



(b) $F_{SCLK} \sim 20$ MHz

FLIR LEPTON 3[®] Long Wave Infrared (LWIR) Datasheet

9.2.1 VoSPI Physical Interface

As illustrated in **Figure 18**, VoSPI utilizes 3 of the 4 lines of a typical SPI channel:

- SCK (Serial Clock)
- /CS (Chip Select, active low),
- MISO (Master In/Slave Out).

Figure 18 - VoSPI I/O

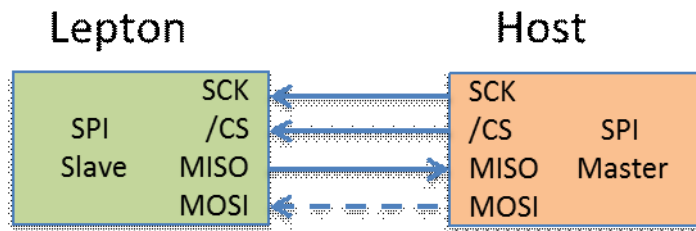

The MOSI (Master Out/Slave In) signal is not currently employed and should be connected to a logic low. Implementations are restricted to a single master and single slave. The Lepton 3 uses SPI Mode 3 (CPOL=1, CPHA=1); SCK is HIGH when idle. Data is set up by the Lepton 3 on the falling edge of SCK and should be sampled by the host controller on the rising edge. See **Figure 19**. Data is transferred most-significant byte first and in big-endian order. **Figure 20** provides an example of the transmission of the value 0x8C08.

Figure 19 - SPI Mode 3 (CPOL=1, CPHA=1)

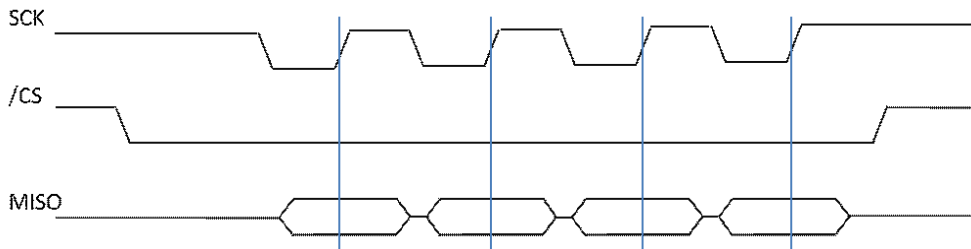
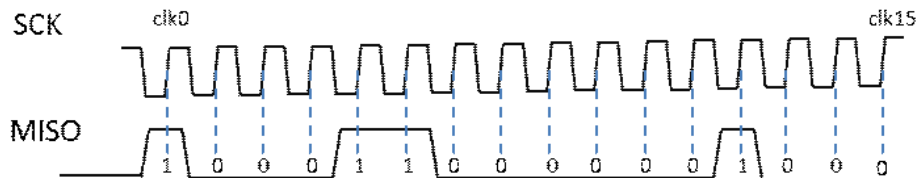

Figure 20 - SPI Bit Order (transmission of 0x8C08)



FLIR LEPTON 3[®] Long Wave Infrared (LWIR) Datasheet

The maximum SPI clock rate is 20 MHz. The minimum clock rate is a function of the number of bits of data per frame that need to be retrieved. As described in the sections that follow, the number of bits of data varies depending upon user settings (video format mode, telemetry mode). For default conditions (Raw14 mode, telemetry disabled), there are 60 video packets per segment, each 1312 bits long, 4 segments per frame, and approximately 26.4 frames per second. Therefore, the minimum rate is on the order of 8.3 MHz.

9.2.2 VoSPI Protocol

The Lepton 3 VoSPI protocol is built on a collection of object types as defined hierarchically below.

- **VoSPI Packet:** The Lepton 3 VoSPI protocol is based on a single standardized VoSPI packet, the minimum “transaction” between master and slave. Each video packet contains data for one half of a video line or telemetry line. In addition to video packets, the VoSPI protocol includes discard packets that are provided when no video packets are available.
- **VoSPI Segment:** A VoSPI segment is defined as a continuous sequence of VoSPI packets consisting of one quarter of a frame of pixel data. To maintain synchronization, it is necessary to read out each VoSPI segment before the next is available.
- **VoSPI Stream:** A VoSPI stream is defined as a continuous sequence of VoSPI segments.

As summarized in [Table 9](#), the packet length and number of packets per frame vary depending upon two runtime user selections, telemetry mode and bit resolution.

- Telemetry mode:
 - Telemetry disabled (default)
 - Telemetry enabled
- Video Format mode:
 - Raw14 (default)
 - RGB888

Table 9 - Packet Length and Number of Video Packets per Frame as a Function of User Settings

Video Format Mode	Telemetry Mode	
	Telemetry Disabled	Telemetry Enabled
Raw14	Packet length: 164 bytes Video packets per segment: 60	Packet length: 164 bytes Video packets per segment: 61
RGB888	Packet length: 244 bytes Video packets per segment: 60	Packet length: 244 bytes Video packets per segment: 61 See note below ¹

Note(s)

1. While it is possible to enable telemetry in RGB mode, the telemetry data is invalid.



FLIR LEPTON 3[®] Long Wave Infrared (LWIR) Datasheet

9.2.2.1 VoSPI Packets

As depicted in [Figure 21](#), each packet contains a 4-byte header followed by either a 160-byte or 240-byte payload. Note: because the payload size differs between video formats, the setting should be selected *before* VoSPI synchronization is established. If the setting is changed while VoSPI is active, it is necessary to re-synchronize (see [VoSPI Stream, page 43](#)).

Figure 21 - Generic VoSPI Packet

ID	CRC	Payload
4 bytes		160 or 240 bytes (depending upon bit resolution setting)

For video packets, the header includes a 2-byte ID and a 2-byte CRC. The ID field encodes the segment number (1, 2, 3, or 4) and the packet number required to determine where the packet belongs in relation to the final 160 x 120 image (or 160x122 if telemetry is enabled). The segment and packet location in each frame is exemplified in [Figure 22](#). Recall that with telemetry disabled, each segment is comprised of 60 packets, each containing pixel data for half of a video line. With telemetry enabled, each segment is comprised of 61 packets.



Information on this page is subject to change without notice.
500-0726-01, Lepton 3 Datasheet, Rev: 100

FLIR LEPTON 3[®] Long Wave Infrared (LWIR) Datasheet

Figure 22 - Segment and Packet Relationship to the 160x120 video image

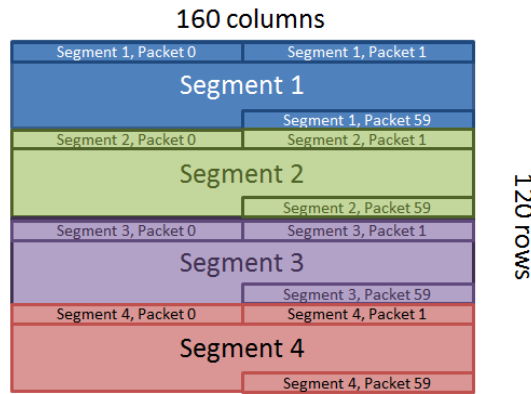

(a) Frame contents with telemetry disabled

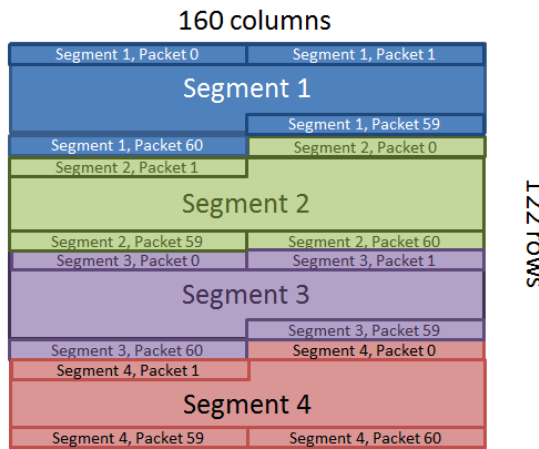

(b) Frame contents with telemetry enabled

As shown in [Figure 23](#), the first bit of the ID field is always a zero. The next three bits are referred to as the TTT bits, and the following 12 are the packet number. Note that packet numbers restart at 0 on each new segment. For all but packet number 20, the TTT bits can be ignored. On packet 20, the TTT bits encode the segment number (1, 2, 3, or 4). The encoded segment number can also have a value of zero. In this case the entire segment is invalid data and should be discarded. [Figure 23](#) also shows an example of Packet 20 of Segment 3.

FLIR LEPTON 3[®] Long Wave Infrared (LWIR) Datasheet

Figure 23 - Packet Header Encoding and an Example

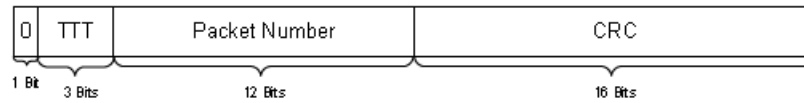

(a) Generic Encoding of the packet header

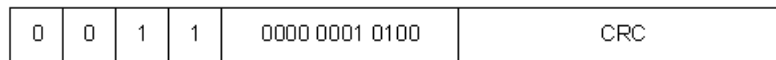

(b) Example showing the packet header for line 20 of segment 3

The CRC portion of the packet header contains a 16-bit cyclic redundancy check (CRC), computed using the following polynomial:

$$x^{16} + x^{12} + x^5 + x^0$$

The CRC is calculated over the entire packet, including the ID and CRC fields. However, the four most-significant bits of the ID and all sixteen bits of the CRC are set to zero for calculation of the CRC. There is no requirement for the host to verify the CRC. However, if the host does find a CRC mismatch, it is recommended to re-synchronize the VoSPI stream to prevent potential misalignment.

At the beginning of SPI video transmission until synchronization is achieved (see [VoSPI Stream, page 43](#)) and also in the idle period between frames, Lepton 3 transmits discard packets until it has a new frame from its imaging pipeline. As shown in [Figure 24](#), the 2-byte ID field for discard packets is always xFxx (where 'x' signifies a “don't care” condition). Note that VoSPI-enabled cameras do not have vertical resolution approaching 3840 lines (0xF00), and therefore it is never possible for the ID field in a discard packet to be mistaken for a video line. Discard packets and invalid segments are to be ignored.

Figure 24 - Discard Packet

ID	CRC	Payload
xFxx	xxxx	Discard data (same number of bytes as video packets)

For video packets, the payload contents depend upon the selected bit resolution.

- For Raw14 mode (the default case), the payload is 160 bytes long. Excluding telemetry lines¹, each packet contains pixel data for all 80 pixels in a single video line (with AGC disabled, the first two bits of each pixel's two-byte word are always set to 0; if AGC is enabled, the first eight bits are set to 0).



Information on this page is subject to change without notice.
500-0726-01, Lepton 3 Datasheet, Rev: 100

FLIR LEPTON 3[®] Long Wave Infrared (LWIR) Datasheet

- For RGB888 mode, the payload is 240 bytes long. Excluding telemetry lines (which are invalid in RGB mode), each packet consists of pixel data for a single video line (3 bytes per pixel).

Each case is illustrated in the following payload encoding figures.

Figure 25 - Raw14 Mode: 1 video line per 160-byte payload

Byte 0	Byte 1	Byte 2	Byte 3	...	Byte 158	Byte 159
Line m		Line m		...	Line m	
Pixel 0		Pixel 1			Pixel 79	

Figure 26 - RGB888 Mode: 1 video line per 240-byte payload

Byte 0	Byte 1	Byte 2	Byte 3	Byte 4	Byte 5	...	Byte 237	Byte 238	Byte 239
Line m	Line m	Line m	Line m	Line m	Line m	...	Line m	Line m	Line m
Pixel 0	Pixel 0	Pixel 0	Pixel 1	Pixel 1	Pixel 1		Pixel 79	Pixel 79	Pixel 79
R	G	B	R	G	B		R	G	B

Note(s)

1. See [TelemetryModes, page 23](#) for payload contents of the telemetry lines

9.2.2.2 VoSPI Segments

Each valid Lepton 3 segment contains data for one quarter of a complete frame. With telemetry disabled, each segment includes 60 packets comprising 30 video rows. When telemetry is enabled, each segment includes 61 packets comprising 30.5 rows. Note that with telemetry enabled, two rows (4 packets) of pixel data is replaced by the telemetry lines; pixel data is either shifted down in which the bottom two rows are excluded (header mode) or up in which the top two rows are excluded (footer mode). With telemetry enabled as a header, packets 0 -3 of segment 1 provide the telemetry data and the remaining 57 packets of segment 1 provide data for the first 28.5 rows of pixel data. Segments 2, 3, and 4 each provide data for 30.5 rows of pixel data. When telemetry is enabled as a footer, segments 1, 2, and 3 each provide data for 30.5 rows of pixel data whereas packets 0 – 56 of segment 4 contain 28.5 rows of pixel data, and packets 57 – 60 provide the telemetry data. The location of the telemetry lines is illustrated in [Figure 27](#).



FLIR LEPTON 3[®] Long Wave Infrared (LWIR) Datasheet

Figure 27 - Location of Telemetry Lines

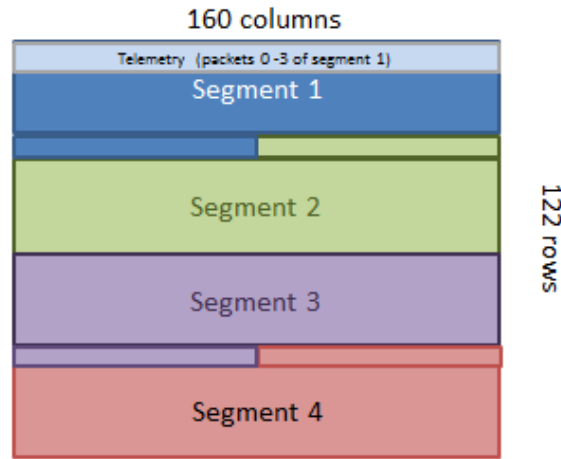

(a) Telemetry as header

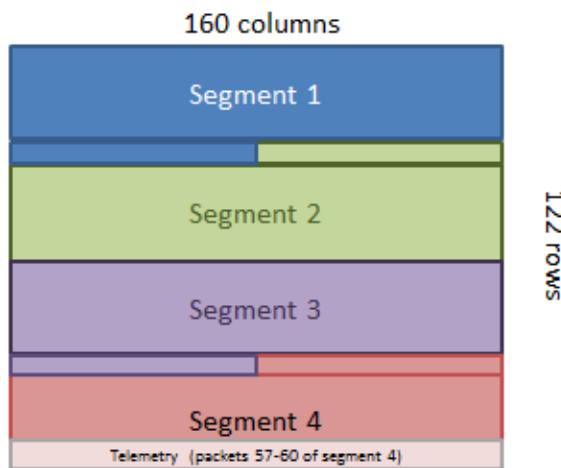

(b) Telemetry as footer

9.2.2.3 VoSPI Stream

A VoSPI stream is simply a continuous sequence of VoSPI segments following a synchronization event. Provided that synchronization is maintained, a VoSPI stream can continue indefinitely. The segment rate is approximately 106 Hz, which equates to a frame rate of ~ 26.5 Hz. However, the rate of *unique* and *valid* frames is just below 9 Hz to comply with US export restrictions. For each unique frame, two partial and invalid frames follow in the VoSPI stream. This pattern is illustrated in [Figure 28](#), with unique frames shown in blue and invalid frames shown in gray. The 32-bit frame counter provided in the telemetry lines (see [Telemetry](#)



Information on this page is subject to change without notice.
500-0726-01, Lepton 3 Datasheet, Rev: 100

FLIR LEPTON 3[®] Long Wave Infrared (LWIR) Datasheet

Modes, page 23) only increments on new frames, which is also illustrated in *Figure 28*. The segment numbers will follow accordingly: 1, 2, 3, 4, 0, 0, 0, 0, 0, 0, 0, 0, 1, 2, 3, 4, etc, where unique frames are comprised of segment numbers 1, 2, 3, 4 and invalid frames are comprised of zeros for each segment number.

Figure 28 - Frame Counter for Successive Frames

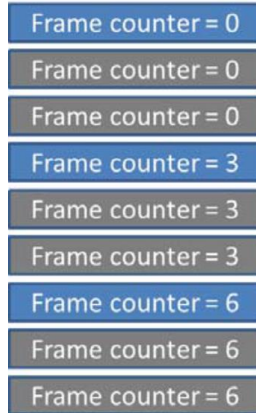

NOTE: Blue frames are different than the previous frames, gray frames are invalid.

9.2.2.3.1 Establishing/Re-Establishing Sync

The basic process for establishing synchronization is listed below:

- Deassert /CS and idle SCK for at least 5 frame periods (>185 msec). This step ensures a timeout of the VoSPI interface, which puts the Lepton 3 in the proper state to establish (or re-establish) synchronization.
- Assert /CS and enable SCLK. This action causes the Lepton 3 to start transmission of a first packet.
- Examine the ID field of the packet, identifying a discard packet. Read out the entire packet.
- Continue reading packets. When a new segment is available (should be less than 10 msec after asserting /CS and reading the first packet), the first video packet will be transmitted. The master and slave are now synchronized.

9.2.2.3.2 Maintaining Segments

There are three main violations that can result in a loss of synchronization:



Information on this page is subject to change without notice.
500-0726-01, Lepton 3 Datasheet, Rev: 100

FLIR LEPTON 3[®] Long Wave Infrared (LWIR) Datasheet

- Intra-packet timeout. Once a packet starts, it must be completely clocked out within 3 line periods. Provided that VoSPI clock rate is appropriately selected and that /CS is not de-asserted (or SCLK disrupted) in the midst of the packet transfer, an intra-packet timeout is an unexpected event.
- Failing to read out all packets for a given segment before the next segment is available. Two examples of this violation are shown in [Figure 30](#) and [Figure 31](#). Note that the vertical blue line shown in the illustrations represents an internal sync signal that indicates a new segment is ready for read-out.
- Failing to read out all available segments. This violation is depicted in
- [Figure 32](#). Note that the requirement to read out all segments applies to both the unique and the invalid frames.

A CRC error does not result in an automatic loss of synchronization. However, as mentioned previously, it is recommended to intentionally re-synchronize (de-assert /CS for >185 msec) following a CRC error.

The following figures are examples of violations that result in a loss of synchronization.

Figure 29 - Valid Frame Timing (no loss of synchronization)

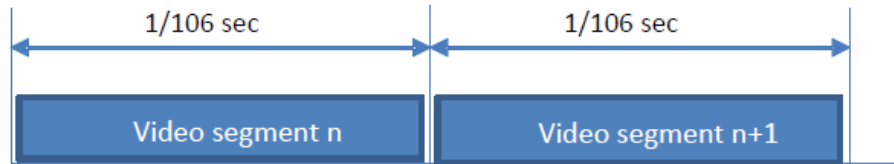

Figure 30 - Clock Too Slow - Failure to Read an Entire Frame Within the Frame Period

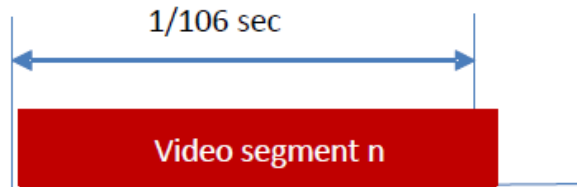
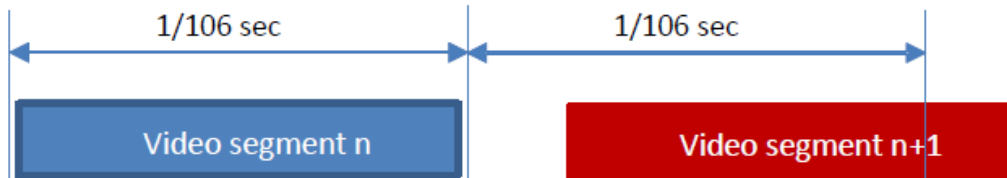

Figure 31 – Intra-frame Delay Too Long - Failure to Read Out an Entire Frame Before the Next is Available



Information on this page is subject to change without notice.
500-0726-01, Lepton 3 Datasheet, Rev: 100

FLIR LEPTON 3[®] Long Wave Infrared (LWIR) Datasheet

Figure 32 - Failure to Read Out an Available Frame

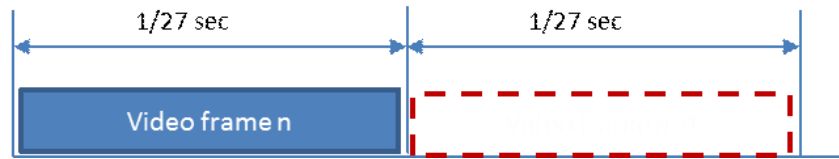

9.2.3 Frame Synchronization

The VoSPI protocol is designed such that embedded timing signals are not required. However, the Lepton 3 does provide an optional output pulse that can aid in optimizing host timing. For example, the host can burst-read data at a high clock rate and then idle until the next pulse is received. The pulse is enabled by selecting the VSYNC GPIO mode via the CCI; when enabled, it is provided on the GPIO3 pin (see [GPIO Modes, page 32](#)). The signal can be configured (also via the CCI) to lead or lag the actual internal start-of-segment (that is, the time at which the next segment is ready to be read) by -3 to +3 line periods (approximately -1.5 msec to +1.5 msec). By default, the pulse does not lead or lag.

9.2.4 VoSPI Protocol, Lepton vs. Lepton 3

This section is provided for customers already familiar with the Lepton VoSPI protocol. It concisely summarizes the difference between Lepton and Lepton 3. Much of the protocol is identical, including the following:

- 1) The physical layer is identical, including the SPI mode and timing.
- 2) The minimum VoSPI transaction is a packet, consisting of 164 bytes of data when in Raw14 video mode or 244 bytes of data when in RGB888 mode. The packet protocol, including the packet header and payload, are unchanged. However, it is worth noting a single packet represented a single 80-pixel video line for Lepton whereas it represents half of a 160-pixel video line in Lepton 3.
- 3) The synchronization requirements are identical with one exception. To maintain synchronization, Lepton requires each video frame to be read out prior to the next available frame. In contrast, Lepton 3 requires each *segment* to be read out prior to the next available segment, where a segment represents one-quarter of a video frame. Lepton 3 sync pulse cannot be used to synchronize external circuitry to frames.
- 4) For both Lepton and Lepton 3, each unique video frame is followed by two non-unique frames which must be read out to maintain synchronization. For Lepton each unique video frame is duplicated twice. For Lepton 3 each unique frame is followed by two partial, invalid frames.

The four most significant differences between the Lepton VoSPI interface and that for Lepton 3 are:

- 1) For Lepton, reconstructing a video frame from the individual packets requires the host to decode the packet number from each packet header. For Lepton 3, the host must decode both the packet number and the segment number.
- 2) There is 4X more data to be read per frame on Lepton 3 compared to Lepton. Therefore, the minimum SPI clock rate to read a frame of data is 4X higher.
- 3) If the sync pulse is enabled (see section 9.2.3), its frequency is 4X higher on Lepton 3 than on



Information on this page is subject to change without notice.
500-0726-01, Lepton 3 Datasheet, Rev: 100

FLIR LEPTON 3[®] Long Wave Infrared (LWIR) Datasheet

Lepton. For Lepton 3, the sync pulse represents when the next available segment is available whereas for Lepton it indicates when the next available frame is available.

- 4) When telemetry is enabled in Lepton, it results in three extra video lines (63 total packets per frame). When telemetry is enabled in Lepton 3, it results in 1 additional packet per segment for a total of 2 extra video lines.

10.0 Thermal Camera Basics

It is noteworthy that the integration period for a thermal detector does not have the same impact on image formation as it does for a photon detector, such as a typical CMOS array. A photon detector converts incoming photons to electrons with near-instantaneous response time but only collects information from the scene during the integration period. In other words, high-speed phenomena (such as a strobed signal) can be missed entirely if the resulting photons are incident at a point in time when the detector is not integrating. A thermal detector, on the other hand, is always changing temperature in response to incident radiation. In other words, it is always “active” regardless of whether or not it is being actively integrated. The integration period only refers to the time that resistance is being sensed by integration of current, not the time the sensor is actively responding to irradiance from the scene. The ability to detect high-speed phenomena is more a function of the detector's thermal time constant, which governs the rate of temperature change. For Lepton 3, the detector time constant is on the order of 12 msec, which means that an instantaneous irradiance change will result in a temperature change of the detector as shown in [Figure 33](#).

Figure 33 - Illustration of Lepton 3 Detector Time Constant

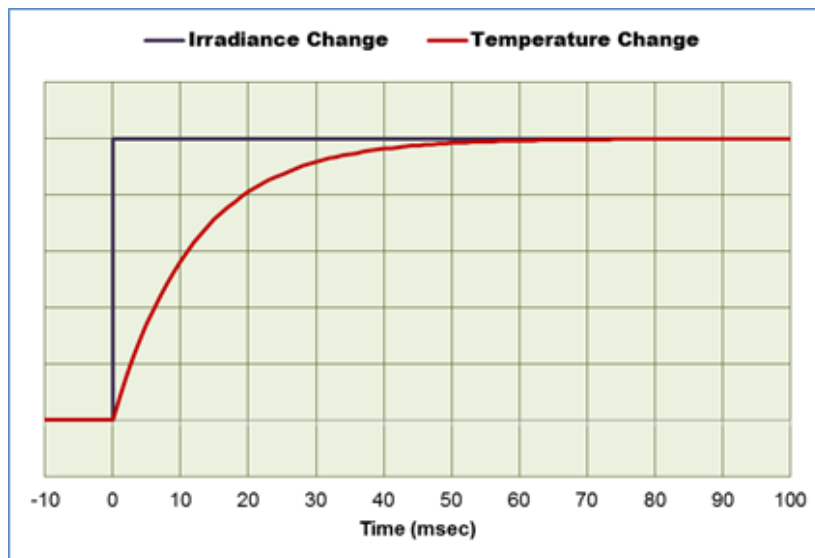

In addition to integrating signal current, the ROIC also digitizes and multiplexes the signal from each detector into a serial stream. And the Lepton 3 ROIC digitizes data from an on-chip temperature sensor as well as a thermistor attached to the camera housing. An anti-reflection (AR) coated window is bonded above the sensor array via a wafer-level packaging (WLP) process, encapsulating the array in a vacuum. The purpose of the vacuum is to provide high thermal resistance between the microbolometer elements and the ROIC substrate, allowing for maximum temperature change in response to incident radiation.



Information on this page is subject to change without notice.
500-0726-01, Lepton 3 Datasheet, Rev: 100

FLIR LEPTON 3[®] Long Wave Infrared (LWIR) Datasheet

11.0 Mounting Specifications

The Lepton 3 camera mounting dimensions are shown in [Figure 34](#). The normal image orientation is defined by the positioning the single tab at the top and the two tabs at the bottom.

Figure 34 - Lepton 3 (nominal 56deg HFOV lens) Camera Mounting Dimensions

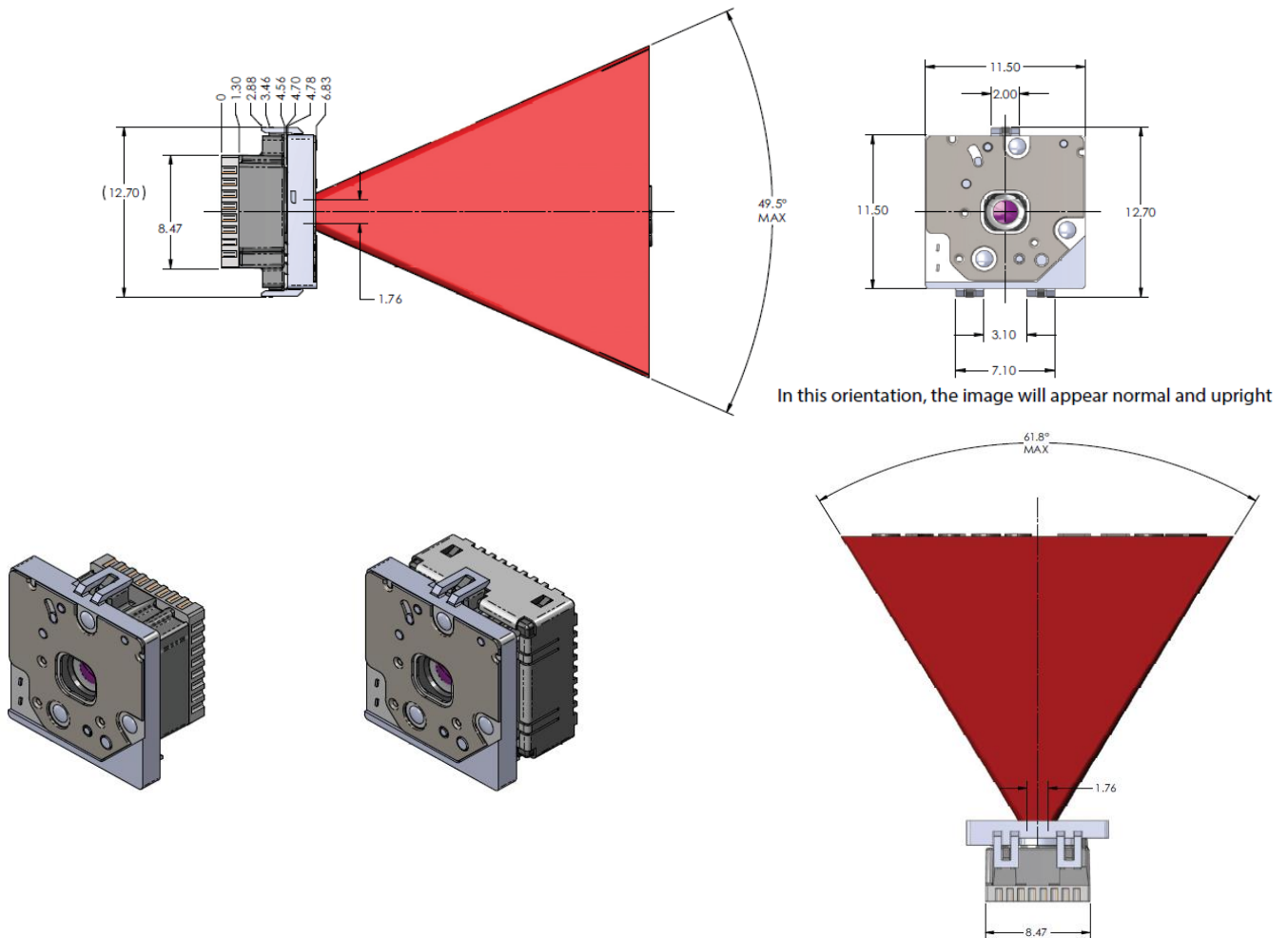

FLIR LEPTON 3[®] Long Wave Infrared (LWIR) Datasheet

11.1 Socket Information

The Lepton 3 module is compatible with two commercially-available sockets, Molex 105028-1001 and Molex 105028-2031, illustrated in [Figure 35](#) below. The former makes electrical contact on the upper surface of a printed circuit board, the latter to the lower surface (with a cutout in the board that allows the socket to pass through). [Figure 36](#) depicts both socket configurations mounted on a PCB.

To order sockets, visit www.arrow.com.

Figure 35 - Two Commercially-available Sockets (both from Molex) Compatible with Lepton 3

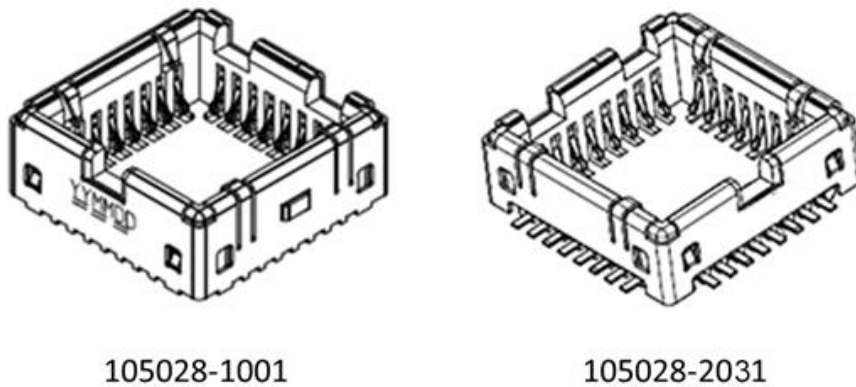
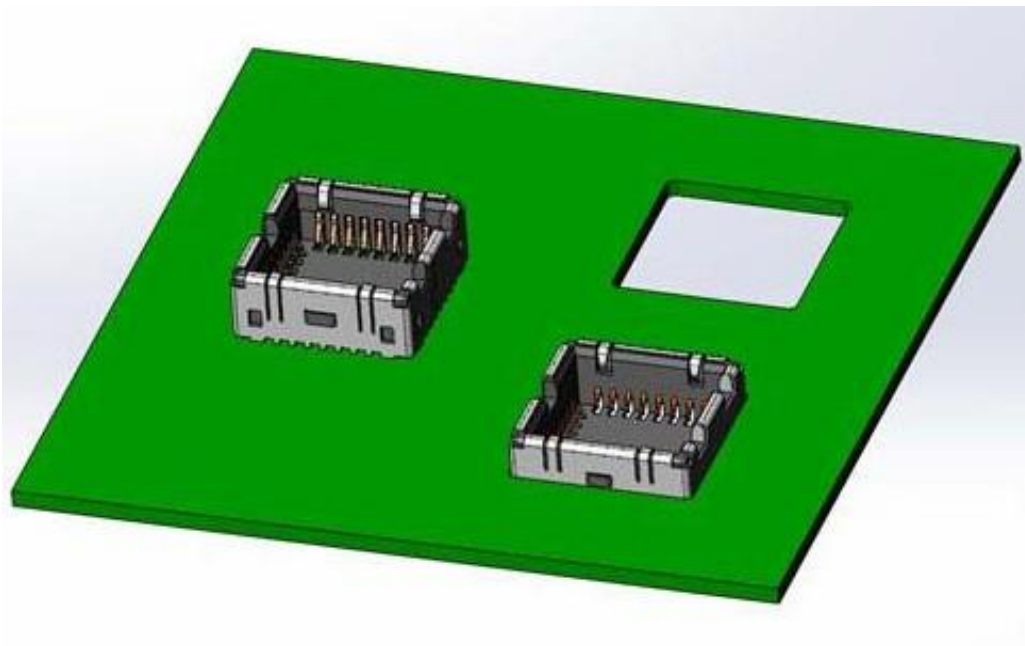

Figure 36 - Both Sockets Mounted on a PCB



FLIR LEPTON 3[®] Long Wave Infrared (LWIR) Datasheet

11.2 Mechanical Considerations

The socket described in [Figure 35](#) is not intended to retain the Lepton 3 assembly under high-shock conditions. It is recommended to incorporate front-side retention such as illustrated in [Figure 37](#). Note that a maximum, uniform, load of 1KgF can be applied to the shutter face without causing failures in the shutter actuation.

Figure 37 - Recommended Approach to Retaining Lepton 3 in the end Application

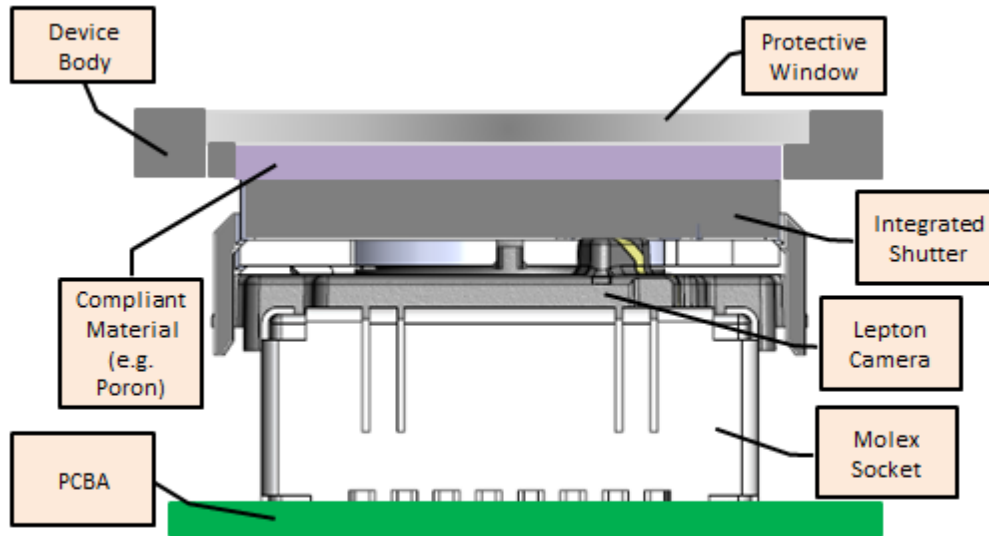

The Lepton 3 camera is not a sealed assembly. Consequently, for most applications it is recommended to locate the assembly behind a sealed protective window. Common materials for LWIR windows include silicon, germanium, and zinc selenide. LWIR absorption in silicon is on the order of 15%/mm, which means NETD is adversely affected using a silicon window. Bulk absorption in germanium and zinc selenide is negligible, and performance is essentially unchanged provided both surfaces of the window are anti-reflection (AR) coated. Note that the window should be sized large enough to avoid encroaching upon the optical keepout zone (see [Optical Considerations, page 51](#)).

11.3 Thermal Considerations

It is important to minimize any temperature gradient across the camera. The sensor should be mounted in a manner intending to isolate it from heat loads such as electronics, heaters, and non-symmetric external heating.

The surrounding area must be able to support and withstand the dissipation of up to 160 mW of heat by the camera.



Information on this page is subject to change without notice.
500-0726-01, Lepton 3 Datasheet, Rev: 100

FLIR LEPTON 3[®] Long Wave Infrared (LWIR) Datasheet

11.4 Optical Considerations

The optical keepout zone is described by the three-dimensional field of view cone within the mechanical STEP files for each Lepton 3 configuration. The Lepton 3 (FLIR Part Number: 500-0726-01) 56deg HFOV configuration STEP files are available upon request. To avoid mechanical vignetting, do not impinge upon the keepout zone defined by this cone.

12.1 Image Characteristics

The information given in [Table 10](#) applies across the full operating temperature range.

Table 10 - Image Characteristics

Parameter	Description	Value
NETD	Noise Equivalent Temperature Difference (random temporal noise)	<50 mK, radiometry mode (35 mK typical)
Intrascene Range	Minimum and maximum scene temperature	0°C to 120°C typical ¹
Operability	Number of non-defective pixels	>99.0% (<1 defect typical)
Clusters	Number of adjacent defective pixels “Adjacent” means any of the 8 nearest neighbors (or nearest 5 for an edge pixel, nearest 3 for a corner).	No more than two adjacent defects

Note(s)

1. Scene dynamic range is a function of sensor characteristics and ambient temperature. Range values reported are typical values at room temperature.



Information on this page is subject to change without notice.
500-0726-01, Lepton 3 Datasheet, Rev: 100

FLIR LEPTON 3[®] Long Wave Infrared (LWIR) Datasheet

The nominal curve of on-axis modulation transfer function (MTF) for the Lepton 3 lens assembly is shown for reference in [Figure 38](#).

Figure 38 - Nominal Curve of On-axis Modulation Transfer Function (MTF)

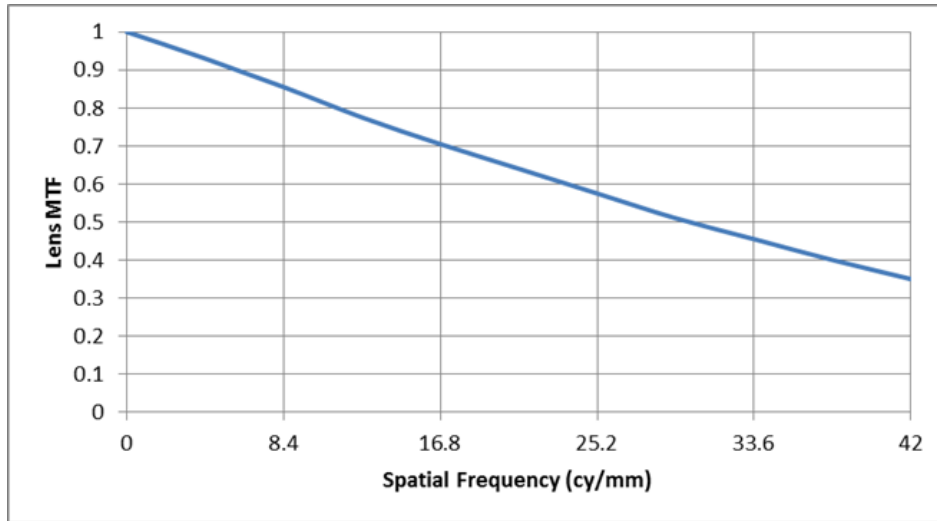

12.0 Spectral Response

For reference, [Figure 39](#) depicts the spectral response of the Lepton 3 camera.

Figure 39 - Normalized Response as a Function of Signal Wavelength

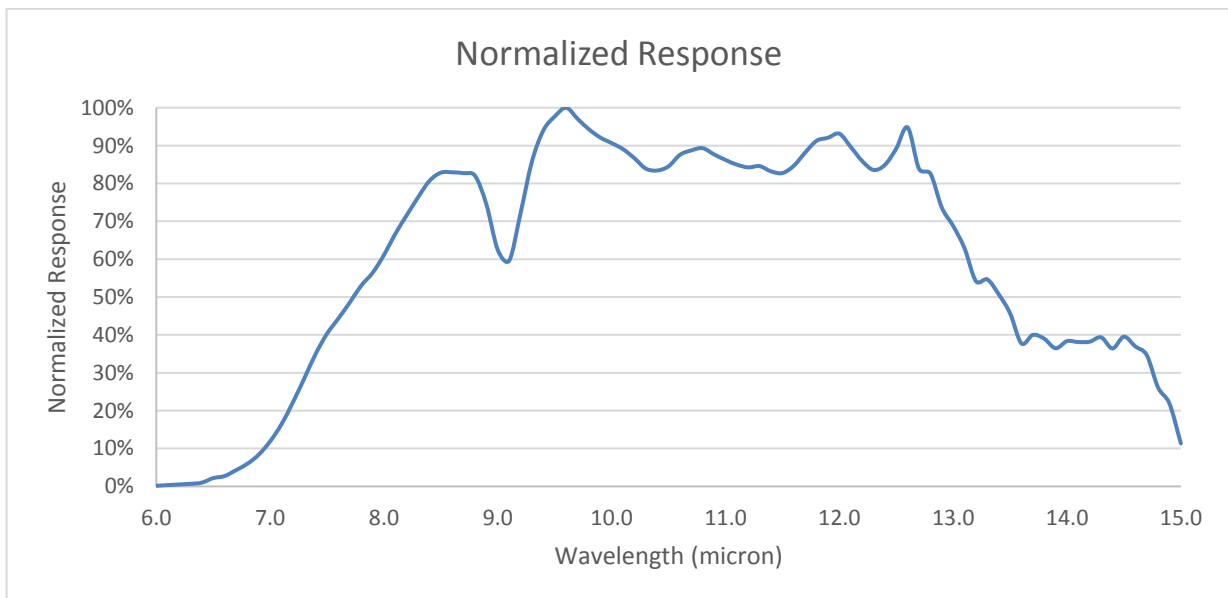

Information on this page is subject to change without notice.
500-0726-01, Lepton 3 Datasheet, Rev: 100

FLIR LEPTON 3[®] Long Wave Infrared (LWIR) Datasheet

13.0 Electrical Specifications

13.1 DC and Logic Level Specifications

Table 11 - DC and Logic Levels

Symbol	Parameter	Min	Typ	Max	Units
VDDC	Core Voltage (primary power for the Lepton 3 internal ASIC)	1.14	1.20	1.26	Volts
VDDC _{pp}	VDDC, peak-to-peak ripple voltage	—	—	50	mV
VDD	Sensor Voltage (primary power for the Lepton 3 internal sensor chip)	2.72	2.80	2.88	Volts
VDD _{pp}	VDD, peak-to-peak ripple voltage	—	—	30	mV
VDDIO	I/O Voltage (primary power for the Lepton 3 I/O ring)	2.8	—	3.1	Volts
VDDIO _{pp}	VDDIO, peak-to-peak ripple voltage	—	—	50	mV
I_DDC	Supply current for core (VDDC)	76	84	110	mA
I_DD	Supply current for sensor (VDD)	12	14	16 ¹	mA
I_DDIO	Supply current for I/O ring and shutter assembly (VDDIO)	1	235 (during FFC)	310 ² (during FFC)	mA

Note(s)

1. Maximum at 65 degrees C
2. Maximum at -10 degrees C
3. FLIR recommends utilizing two separate power supplies rather than a common supply for VDD and VDDIO due to noise considerations.

13.2 AC Electrical Characteristics

Table 12 - AC Electrical Characteristics

Parameter	Min	Typ	Max	Units
MASTER_CLK, F _{clk}	See note ¹	25 MHz	See note ²	Master clock rate
MASTER_CLK, F _{clk} duty	45%	50%	55%	Master clock duty cycle
MASTER_CLK, t _r	--	--	3.4ns	Clock rise time (10% to 90%)



Information on this page is subject to change without notice.
500-0726-01, Lepton 3 Datasheet, Rev: 100

FLIR LEPTON 3[®] Long Wave Infrared (LWIR) Datasheet

MASTER_CLK, tr	--	--	3.4ns	Clock fall time (90% to 10%)
SPI_CLK, F _{clk}	See note ³		20 MHz	VoSPI clock rate
SPI_CLK, F _{clk} duty	45%	50%	55%	SPI-clock duty cycle
SPI_CLK, tr	--	--	TBD	SPI clock rise time (10% to 90%)
SPI_CLK, tr	--	--	TBD	SPI clock fall time (90% to 10%)
SCL, F _{clk}			1 MHz	I2C clock rate
SCL, F _{clk} duty	45%	50%	55%	I2C-clock duty cycle
SCL_CLK, tr	--	--	TBD	I2C clock rise time (10% to 90%)
SCL_CLK, tr	--	--	TBD	I2C clock fall time (90% to 10%)

Note(s)

1. Master clock frequencies significantly less than 25MHz may cause image degradation.
2. Master clock frequencies significantly above 25.5MHz will cause the camera to stop displaying live sensor data and display an overclock test pattern.
3. As described in [VoSPI Protocol, page 38](#), the minimum VoSPI clock frequency is dependent upon the requirement to read out all video packets for a given frame within the frame period. The size and number of video packets vary with user settings.

13.3 Absolute Maximum Ratings

Electrical stresses beyond those listed in [Table 11](#) may cause permanent damage to the device. These are stress rating only, and functional operation of the device at these or any other conditions beyond those indicated under the recommended operating conditions listed in [Table 11](#) is not implied. Exposure to absolute-maximum-rated conditions for extended periods of time may affect device reliability.

Table 13 - Absolute Maximum Ratings

Parameter	Absolute Maximum Rating
Core Voltage (VDDC)	1.5 V
Sensor Voltage (VDD)	4.8 V
I/O Voltage (VDDIO)	4.8V
Voltage on any I/O pin	Lesser of (VDDIO + 0.6V) or 4.8V



Information on this page is subject to change without notice.
500-0726-01, Lepton 3 Datasheet, Rev: 100

FLIR LEPTON 3[®] Long Wave Infrared (LWIR) Datasheet

14.0 Environmental Specifications

Environmental stresses beyond those listed may cause permanent damage to the device. Exposure to absolute-maximum-rated conditions for extended periods of time may affect device reliability.

Table 14 - Environmental Specifications

Stress	Maximum Rating
Operating Temperature Range	-10° C to 65° C (-20° C to 80° C with some possible performance degradation)
Maximum Operating Temperature	80 °C ¹
Shutter Operating Temperature	-10° C to 65° C ²
Storage Temperature	-40° C to 80° C
Altitude (pressure)	12 km altitude equivalent
Relative Humidity	95%
Thermal Shock	Air-to-air across operating temperature extremes (-10° C to 65° C, 65° C to -10° C)
Mechanical Shock	1500 g, 0.4 msec
Vibration	Transportation profile, 4.3 grms
ESD	Human Body Model (HBM), 2kV Charged Device Model (CDM), 500V

Note(s)

1. Lepton 3 contains an automatic shutdown feature when its internal temperature exceeds the maximum safe operating value. See [Power States, page 17](#).
2. Lepton 3 contains an automatic shutter lockout feature that prevents the shutter from operating when its internal temperature is outside the range of -10° C to 65° C. See [FFC States, page 20](#).

14.1 Compliance with Environmental Directives

Lepton 3 complies with the following directives and regulations:

- Directive 2002/95/EC, "Restriction of the use of certain Hazardous Substances in electrical and electronic equipment (RoHS)"
- Directive 2002/96/ EC, "Waste Electrical and Electronic Equipment (WEEE)".
- Regulation (EC) 1907/2006, "Registration, Evaluation, Authorization and Restriction of Chemicals (REACH)"



Information on this page is subject to change without notice.
500-0726-01, Lepton 3 Datasheet, Rev: 100

FLIR LEPTON 3[®] Long Wave Infrared (LWIR) Datasheet

15.0 Abbreviations and Acronyms

Abbreviation	Description
AGC	Automatic Gain Control
AR	Anti-reflection
CCI	Command and Control Interface
CRC	Cyclic Redundancy Check
DSP	Digital Signal Processor
EMC	Electromagnetic Compatibility
FFC	Flat Field Correction
FOV	Field of View
FPA	Focal Plane Array
FPN	Fixed Pattern Noise
GPIO	General Purpose IO
HFOV	Horizontal Field of View
I2C	Inter-Integrated Circuit
IDD	Interface Description Document
LWIR	Long Wave Infrared
MISO	Maser In/Slave Out
MOSI	Master Out/Slave In
NEDT	Noise Equivalent Differential Temperature
NUC	Non-Uniformity Correction
OTP	One-Time Programmable
PLL	Phase-Lock Loop
REACH	Registration, Evaluation, Authorization, and Restriction of Chemicals



Information on this page is subject to change without notice.
500-0726-01, Lepton 3 Datasheet, Rev: 100

FLIR LEPTON 3[®] Long Wave Infrared (LWIR) Datasheet

RoHS	Reduction of Hazardous Substances
ROIC	Readout Integrated Circuit
SBNUC	Scene-based Non-uniformity Correction
SNR	Signal to Noise Ratio
SoC	System on a Chip
SPI	Serial Peripheral Interface
SVP	Software-based Video Processing
TCR	Temperature Coefficient of Resistance
TWI	Two-wire Interface
VoSPI	Video Over SPI
VOx	Vanadium-oxide
WEEE	Waste Electrical and Electronic Equipment
WLP	Wafer-level Packaging



Information on this page is subject to change without notice.
500-0726-01, Lepton 3 Datasheet, Rev: 100

FLIR LEPTON 3[®] Long Wave Infrared (LWIR) Datasheet

© FLIR Commercial Systems, 2014. All rights reserved worldwide. No parts of this manual, in whole or in part, may be copied, photocopied, translated, or transmitted to any electronic medium or machine readable form without the prior written permission of FLIR Commercial Systems

Names and marks appearing on the products herein are either registered trademarks or trademarks of FLIR Commercial Systems and/or its subsidiaries. All other trademarks, trade names, or company names referenced herein are used for identification only and are the property of their respective owners.

Liberation fonts are copyright 2009 by RedHat and are used under authority of the GNU public license. Information about these fonts and the GNU public license can be found at: <https://www.redhat.com/promo/fonts/>.

This product is protected by patents, design patents, patents pending, or design patents pending.

If you have questions that are not covered in this manual, or need service, contact FLIR Commercial Systems Customer Support at 805.964.9797 for additional information prior to returning a camera.

This documentation and the requirements specified herein are subject to change without notice.



This equipment must be disposed of as electronic waste. Contact your nearest FLIR Commercial Systems, Inc. representative for instructions on how to return the product to FLIR for proper disposal.

FCC Notice. This device is a subassembly designed for incorporation into other products in order to provide an infrared camera function. It is not an end-product fit for consumer use. When incorporated into a host device, the end-product will generate, use, and radiate radio frequency energy that may cause radio interference. As such, the end-product incorporating this subassembly must be tested and approved under the rules of the Federal Communications Commission (FCC) before the end-product may be offered for sale or lease, advertised, imported, sold, or leased in the United States. The FCC regulations are designed to provide reasonable protection against interference to radio communications. See 47 C.F.R. §§ 2.803 and 15.1 et seq.

Industry Canada Notice. This device is a subassembly designed for incorporation into other products in order to provide an infrared camera function. It is not an end-product fit for consumer use. When incorporated into a host device, the end-product will generate, use, and radiate radio frequency energy that may cause radio interference. As such, the end-product incorporating this subassembly must be tested for compliance with the Interference-Causing Equipment Standard, Digital Apparatus, ICES-003, of Industry Canada before the product incorporating this device may be: manufactured or offered for sale or lease, imported, distributed, sold, or leased in Canada.

Avis d'Industrie Canada. Cet appareil est un sous-ensemble conçu pour être intégré à un autre produit afin de fournir une fonction de caméra infrarouge. Ce n'est pas un produit final destiné aux consommateurs. Une fois intégré à un dispositif hôte, le produit final va générer, utiliser et émettre de l'énergie radiofréquence qui pourrait provoquer de l'interférence radio. En tant que tel, le produit final intégrant ce sous-ensemble doit être testé pour en vérifier la conformité avec la Norme sur le matériel brouilleur pour les appareils numériques (NMB-003) d'Industrie Canada avant que le produit intégrant ce dispositif puisse être fabriqué, mis en vente ou en location, importé, distribué, vendu ou loué au Canada.

EU Notice. This device is a subassembly or component intended only for product evaluation, development or incorporation into other products in order to provide an infrared camera function. It is not a finished end-product fit for general consumer use. Persons handling this device must have appropriate electronics training and observe good engineering practice standards. As such, this product does not fall within the scope of the European Union (EU) directives regarding electromagnetic compatibility (EMC). Any end-product intended for general consumer use that incorporates this device must be tested in accordance and comply with all applicable EU EMC and other relevant directives.



Information on this page is subject to change without notice.
500-0726-01, Lepton 3 Datasheet, Rev: 100